



FLAT GLASS PRICE BOOK

Stock Sheet, Cut to Size, Fabrication, Tempering, I.G. Units & Sundries

WHOLESALE PRICING

Effective 05/2023

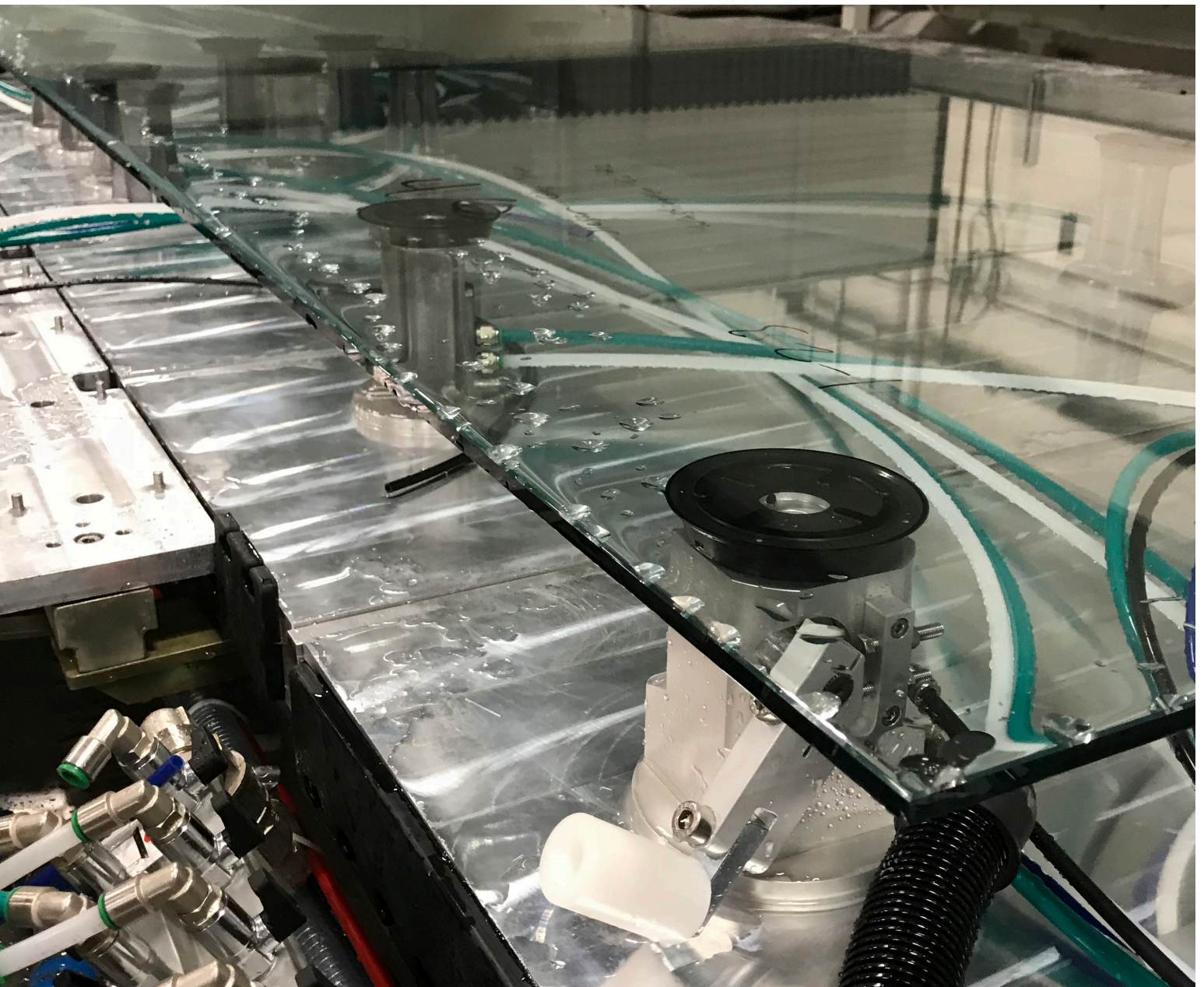

Table of CONTENTS

● STOCK SHEETS

- 4 FLAT GLASS
- 5 MIRROR
- 5 PATTERN GLASS

● FABRICATION

- 6 CUT TO SIZE
- 8 EDGE TREATMENTS
- 9 CORNERS, HOLES & NOTCHES
- 10 PATTERNS
- 11 TEMPERING LIMITATIONS
- 12 PROFILE & SHAPE ILLUSTRATIONS

● TEMPERED GLASS

- 15 DOOR BLANKS
- 16 HG VALUE PACKAGES

● FRAMELESS MIRRORS

- 19 STANDARD SIZE MIRRORS
- 20 DOOR MIRRORS
- 20 FRAMELESS SHAPES

● INSULATED GLASS

- 21 INSULATED GLASS UNITS
- 22 MUNTIN OPTIONS
- 23 INSULATED GLASS DOOR UNITS
- 23 FOAMTITE INTERIOR STORM WINDOWS
- 24 INSULATED GLASS WARRANTY
- 24 INSULATED GLASS PERFORMANCE CHART

● PARTS & SUNDRIES

- 25 INDEX – PARTS
- 26 ANDSCOT METALS
- 27 MIRROR COVER PLATES
- 28 SILICONE
- 28 SUNDRIES
- 29 STYLMARK

○ REFERENCE

- 30 HANG IT™ INSTRUCTIONS
- 31 ROBAX® GLASS
- 32 ENDUROSHIELD

QUOTE REQUESTS - SEND ALL QUOTE REQUESTS TO:

- quotes@wisconsinshowerdoor.com
- Fax to: 262.251.0718

ORDER REQUESTS - SEND TO ORDER REQUESTS TO:

- orders@wisconsinshowerdoor.com
- Fax to: 262.251.0718
- Incomplete orders will be delayed until all information is received; order dates are established once all information is received.

Quotes and Orders will not be processed if sent directly to CSR emails.

Pricing does not include applicable surcharges or taxes and is subject to change without notice.

STOCK SHEET – FLAT GLASS

| | | PRICE PER SQUARE FOOT | | | | | |
|-------|--|--|----------|-------|-------|------------|---------|
| | | VOLUME PRICING <small>(cannot mix DS & SS with 3/16" or thicker for quantity discounts)</small> | | | | | |
| GLASS | | SHEET SIZE | | ONE | FIVE | TEN | TWENTY+ |
| SS | Non-Glare | 36" | 48" | 6.74 | 6.36 | *CASE OF 4 | |
| SS | Non-Glare | 40" | 60" | 13.08 | 12.07 | *CASE OF 2 | |
| SS | Clear Plate <small>(3 Sheet Minimum)</small> | 48 | 84 | 0.91 | 0.86 | 0.82 | 0.79 |
| DS | Clear Plate <small>(2 Sheet Minimum)</small> | 48 72 | 84 84 | 1.20 | 1.13 | 1.08 | 1.04 |
| 3/16" | Clear Plate | 72 | 130 | 2.67 | 2.55 | 2.46 | 2.40 |
| 1/4" | Clear Plate | 48 | 105 | 2.77 | 2.62 | 2.52 | 2.45 |
| | | 48 | 130 | | | | |
| | | 60 | 130 | | | | |
| | | 72 | 130 | | | | |
| 3/8" | Clear Plate | 96 | 130 # | 6.05 | 5.71 | 5.45 | 5.28 |
| 1/2" | Clear Plate | 96 | 130 # | 8.29 | 7.85 | 7.52 | 7.30 |
| 1/4" | Optiwhite | 96 | 130 # | 5.80 | 5.55 | 5.37 | 5.24 |
| 3/8" | Optiwhite | 96 | 130 # | 12.42 | 11.90 | 11.51 | 11.24 |
| 1/2" | Optiwhite | 96 | 130 # | 13.60 | 13.11 | 12.75 | 12.48 |
| 3/4" | Optiwhite <small>(Call for Availability)</small> | 72 | 130 # | 32.25 | 31.09 | 30.22 | 29.60 |
| 3/16 | Robax® | 43 | 77 | 35.79 | | | |
| 1/8" | Bronze/Grey Plate | B: 65 G: 72 | 96 84 | 4.62 | 4.33 | 4.12 | 3.98 |
| 3/16" | Bronze/Grey Plate | 65 | 96 | 4.95 | 4.66 | 4.45 | 4.31 |
| 1/4" | Bronze/Grey Plate | 96 | 130 # | 5.06 | 4.77 | 4.56 | 4.42 |
| 3/8" | Bronze/Grey Plate | 96 | 130 # | 14.87 | 14.16 | 13.65 | 13.28 |
| 1/8" | Midnight Grey | 72 | 84 | 7.25 | 6.79 | 6.47 | 6.25 |
| 1/4" | .030 Clear Laminated | 36 | 84 | 6.87 | 6.63 | 6.44 | 6.31 |
| | | 40 | 80 | | | | |
| | | 48 | 84 | | | | |
| | | 60 | 96 | | | | |
| 1/4" | .030 Bronze Laminated | 40 | 80 | 8.08 | 7.79 | 7.57 | 7.41 |
| 1/4" | .030 Grey Laminated | 40 | 80 | 8.08 | 7.79 | 7.57 | 7.41 |
| 1/4" | .030 Green Laminated | 36 | 84 | 8.08 | 7.79 | 7.57 | 7.41 |
| | | 48 | 84 | | | | |
| 1/4" | .030 Hue White Laminated | 60 | 96 | 9.62 | 9.27 | 9.01 | 8.83 |

Split Sheet Pricing – Price for one (1) cut to split sheet from stock sheet size as follows: # Split sheets require one (1) production day and will not be available for next day delivery.

- SS – 1/4" – \$8.75 one cut
- 3/8" – \$17.50 one cut
- 1/2" – \$17.50 one cut
- 3/4" – \$58.32 one cut (all 3/4" stock must be split)
- Lami – \$17.50 one cut
- Robax – \$11.00 one cut

#Jumbo sheet stock – Split charges apply // WSD will not deliver jumbo stock sheets

STOCK SHEET – MIRROR

| | | PRICE PER SQUARE FOOT | | | | | |
|---|------------|--|-------|-------|---------|--|--|
| | | VOLUME PRICING <small>(cannot mix DS & SS with 3/16" or thicker for quantity discounts)</small> | | | | | |
| MIRROR | SHEET SIZE | ONE | FIVE | TEN | TWENTY+ | | |
| DS Clear Mirror (2 Sheet Minimum) | 48 96 | 2.98 | 2.77 | 2.68 | 2.61 | | |
| 3/16" Clear Mirror | 72 130 | 4.07 | 3.73 | 3.59 | 3.47 | | |
| 1/4" Clear Mirror | 48 120 | 4.33 | 3.95 | 3.79 | 3.67 | | |
| | 60 120 | | | | | | |
| | 72 120 | | | | | | |
| | 72 144 # | | | | | | |
| 1/4" Grey Mirror | 72 130 | 7.98 | 7.31 | 7.02 | 6.80 | | |
| 1/4" Clear Laminated Mirror | 48 84 | 17.34 | 15.60 | 14.86 | 14.32 | | |
| 1/4" Antique Mirror-Clear* ¹ | 72 130 | 9.84 | 9.08 | 8.75 | 8.49 | | |

*Antique Mirror is sold "as-is". This is a custom fabricated product and is not held to normal industry specifications.
¹Sizes may vary depending on availability from supplier

STOCK SHEET – PATTERN GLASS

| PRICE PER SQUARE FOOT | | | | | | | | | |
|-----------------------|---------------------|------------|----|-------|-------|---------------------------|-------------------------|-----|---------|
| GLASS | | SHEET SIZE | | PRICE | GLASS | | SHEET SIZE | | PRICE |
| | | W | H | | | W | H | | |
| 1/8" | Pattern #62 | 72 | 84 | 3.51 | 1/4" | Master Carre ² | 78 | 126 | 10.47 |
| 1/8" | Velour on Soda Lime | 65 | 96 | 8.62 | 1/4" | Pattern #62 | 72 | 84 | 4.89 |
| 5/32" | Cottswald | 52 | 84 | 7.86 | 1/4" | Rain | 72 | 84 | 5.95 |
| 5/32" | Flemish | 72 | 84 | 8.76 | 1/4" | Reeded | 72 | 84 | 7.50 |
| 5/32" | Renaissance | 65 | 85 | 7.67 | 1/4" | Velour on Soda Lime | 96 | 130 | # 7.50 |
| 3/16" | Aquatex | 72 | 84 | 3.80 | 3/8" | Glue Chip – Rolled | 72 | 84 | 15.38 |
| 1/4" | Aquatex | 72 | 84 | 6.02 | 3/8" | Rain | 60 84 72 84 72 96 | | 11.22 |
| 1/4" | Flemish | 72 | 84 | 9.91 | 3/8" | Reeded | 72 | 84 | 12.04 |
| 1/4" | Glue Chip – Rolled | 72 | 84 | 7.25 | 3/8" | Velour on Soda Lime | 96 | 130 | # 11.51 |
| | | | | | 3/8" | Velour on Starphire | 96 | 130 | # 21.30 |
| | | | | | 1/2" | Velour on Soda Lime | 96 | 130 | # 17.96 |

²Discontinued Patterns - Limited quantities, call for availability.

#Jumbo sheet stock – Split charges apply // WSD will not deliver jumbo stock sheets

CUT-TO-SIZE

WSD WILL NOT TEMPER CUSTOMER'S FABRICATED GLASS

PRICE PER SQUARE FOOT

FABRICATION

| | | PRICE | |
|--|--|----------|----------|
| | | ANNEALED | TEMPERED |

PLATE GLASS

| | | | |
|----|---------------------------|-------|--|
| SS | Non-Glare (36" x 48" max) | 8.00 | |
| SS | Non-Glare (40" x 60" max) | 15.75 | |

| | | | |
|-------|-------------|------|-------|
| SS | Clear Plate | 2.74 | |
| DS | Clear Plate | 3.19 | 4.59 |
| 3/16" | Clear Plate | 3.72 | 4.75 |
| 1/4" | Clear Plate | 3.79 | 4.82 |
| 3/8" | Clear Plate | 7.25 | 7.74 |
| 1/2" | Clear Plate | 9.47 | 11.63 |

| | | | |
|------|-----------|-------|-------|
| 1/4" | Optiwhite | 7.36 | 8.34 |
| 3/8" | Optiwhite | 14.94 | 17.01 |
| 1/2" | Optiwhite | 18.97 | 25.70 |
| 3/4" | Optiwhite | 46.63 | |

| | | | |
|-------|--------|-------|--|
| 3/16" | Robax® | 59.09 | |
|-------|--------|-------|--|

TINTED GLASS

| | | | |
|-------|-------------------|-------|-------|
| 1/8" | Bronze/Grey Plate | 6.18 | 6.47 |
| 3/16" | Bronze/Grey Plate | 6.72 | 6.94 |
| 1/4" | Bronze/Grey Plate | 6.93 | 7.24 |
| 3/8" | Bronze/Grey Plate | 19.25 | 22.53 |
| 1/8" | Midnight Grey | 7.83 | 15.31 |

LAMINATED

| | | | |
|------|--------------------------|-------|--|
| 1/4" | .030 Clear Laminated | 10.50 | |
| 1/4" | .030 Bronze Laminated | 11.79 | |
| 1/4" | .030 Grey Laminated | 11.79 | |
| 1/4" | .030 Green Laminated | 11.79 | |
| 1/4" | .030 Hue White Laminated | 13.89 | |

MIRROR

| | | | |
|-------|--------------|------|--|
| 1/8" | Clear Mirror | 4.76 | |
| 3/16" | Clear Mirror | 5.45 | |
| 1/4" | Clear Mirror | 5.64 | |

| | | | |
|------|-------------|------|--|
| 1/4" | Grey Mirror | 9.15 | |
|------|-------------|------|--|

| | | | |
|------|-----------------------------------|-------|--|
| 1/4" | Antique Mirror-Clear ¹ | 12.69 | |
|------|-----------------------------------|-------|--|

| | | | |
|------|------------------------|-------|--|
| 1/4" | Clear Laminated Mirror | 19.52 | |
|------|------------------------|-------|--|

| | | PRICE | |
|--|--|----------|----------|
| | | ANNEALED | TEMPERED |

LOW E (ENERGY ADVANTAGE)

| | | | |
|-------|--------------------------|------|------|
| 1/8" | Low E (Energy Advantage) | 6.60 | 7.52 |
| 3/16" | Low E (Energy Advantage) | 8.06 | 9.09 |

PATTERN GLASS

| | | | |
|------|---------------------|-------|------|
| 1/8" | Clear Seedy | CALL | |
| 1/8" | Clear Water | CALL | |
| 1/8" | German New Antique | 21.90 | |
| 1/8" | Pattern #62 | 6.02 | 6.85 |
| 1/8" | Velour on Soda Lime | 9.48 | 9.82 |

| | | | |
|-------|-------------|-------|--|
| 5/32" | Cottswald | 11.50 | |
| 5/32" | Flemish | 13.80 | |
| 5/32" | Renaissance | 11.22 | |

| | | | |
|-------|---------|------|------|
| 3/16" | Aquatex | 5.86 | 6.89 |
|-------|---------|------|------|

| | | | |
|------|---------|------|-------|
| 1/4" | Aquatex | 9.78 | 12.12 |
|------|---------|------|-------|

| | | | |
|------|----------------------------------|-------|-------|
| 1/4" | White (Back-Painted) on Low-Iron | 16.56 | 18.22 |
|------|----------------------------------|-------|-------|

| | | | |
|------|---------|-------|-------|
| 1/4" | Flemish | 15.82 | 18.17 |
|------|---------|-------|-------|

| | | | |
|------|--------------------|-------|-------|
| 1/4" | Glue Chip – Rolled | 13.18 | 15.72 |
|------|--------------------|-------|-------|

| | | | |
|------|---------------------------|-------|-------|
| 1/4" | Master Carre ² | 15.27 | 17.84 |
|------|---------------------------|-------|-------|

| | | | |
|------|------------|-------|--|
| 1/4" | Misco Wire | 16.94 | |
|------|------------|-------|--|

| | | | |
|------|-------------|------|-------|
| 1/4" | Pattern #62 | 8.70 | 10.36 |
|------|-------------|------|-------|

| | | | |
|------|------|------|-------|
| 1/4" | Rain | 9.16 | 10.90 |
|------|------|------|-------|

| | | | |
|------|--------|-------|-------|
| 1/4" | Reeded | 14.36 | 16.60 |
|------|--------|-------|-------|

| | | | |
|------|---------------------|-------|-------|
| 1/4" | Velour on Soda Lime | 10.18 | 13.21 |
|------|---------------------|-------|-------|

| | | | |
|------|--------------------|-------|-------|
| 3/8" | Glue Chip – Rolled | 24.48 | 27.38 |
|------|--------------------|-------|-------|

| | | | |
|------|--------------------|-------|-------|
| 3/8" | German New Antique | 59.46 | 62.35 |
|------|--------------------|-------|-------|

| | | | |
|------|------|-------|-------|
| 3/8" | Rain | 17.23 | 19.99 |
|------|------|-------|-------|

| | | | |
|------|--------|-------|-------|
| 3/8" | Reeded | 18.70 | 20.72 |
|------|--------|-------|-------|

| | | | |
|------|---------------------|-------|-------|
| 3/8" | Velour on Soda Lime | 19.01 | 21.92 |
|------|---------------------|-------|-------|

| | | | |
|------|---------------------|-------|-------|
| 3/8" | Velour on Starphire | 36.69 | 39.93 |
|------|---------------------|-------|-------|

| | | | |
|------|---------------------|-------|-------|
| 1/2" | Velour on Soda Lime | 32.00 | 37.06 |
|------|---------------------|-------|-------|

¹Antique Mirror is sold "as-is". This is a custom fabricated product and is not held to normal industry specifications.

²Discontinued Patterns - Limited quantities, call for availability.

CUT-TO-SIZE SPECIFICATIONS

FABRICATION

| SPECIFICATIONS & ADDITIONAL CHARGES | | | | | | | | |
|--|---|--------------------------|----------|----------|----------|------------------------------|-------------------|----------|
| | | GLASS THICKNESS | | | | | | |
| | | DS & SS | 5/32 | 3/16" | 1/4" | 3/8" | 1/2" | 3/4" |
| Minimum Quantities | | | | | | | | |
| Annealed - Translucent & Mirror per order | 1 sq ft - All glass thicknesses | | | | | | | |
| Annealed - Pattern Glass | 1 sq ft per piece | | | | | | 3 sq ft per order | |
| Annealed - Robax | No Min. | | | | | | | |
| Tempered - All Glass Types per piece | 3 sq ft - All glass thicknesses | | | | | | | |
| Dimensions & Tolerances | | | | | | | | |
| Out of Square | WSD does not charge for out of square conditions (except for Double Out Conditions) | | | | | | | |
| Double Out Condition On seamed or polished only | \$92.00 | | | | | | | |
| Tolerances | ±1/16" | ±1/16" | ±1/16" | ±1/16" | ±1/8" | ±1/8" | ±3/16" | |
| Hold Exact Size | Add 20% to order | | | | | | | |
| Edgework Requirements | | | | | | | | |
| Annealed | All annealed shipped goods will be seamed // Seaming charges apply (see page 8) | | | | | | | |
| Tempered | All tempered includes seaming in tempering price | | | | | Satin Polish (charges apply) | | |
| Size Charges | | | | | | | | |
| Undersize Items | Lites with a width of less than 10" will be calculated as a minimum of 10" All glass thicknesses | | | | | | | |
| Undersize Charge Charged on items less than 8" down to 2" that require bevel or miter | | | | | | \$103.00 | \$103.00 | \$103.00 |
| Tempered Oversize Charge Charged on glass ≥120" | Add 75% to square foot price | | | | | | | |
| Oversize Charge (per piece) | \$26.95 multiplied by Oversize Quantity | | | | | | | |
| Oversize Quantity = sq ft of piece / thickness figure <i>Note: Oversize Quantity must be 1 or greater for oversize charge to apply</i> | Oversize Quantity Example (using ¼" glass) $\frac{\text{sq ft of piece}}{\text{thickness figure}} = \frac{36 \text{ sq ft}}{24 \text{ sq ft}} = 1.5$ | Thickness Figure (below) | | | | | | |
| | | 24 sq ft | 24 sq ft | 20 sq ft | 15 sq ft | 7 sq ft | | |
| Other Charges | | | | | | | | |
| EnduroShield - Both Sides | Add \$3.66 per sq ft X sq ft of piece | | | | | | | |
| Tempering Limitations - Additional tempering limitations can be found on page 11 | | | | | | | | |

EDGE TREATMENTS

| TREATMENT | STRAIGHT LINE EDGE TREATMENT | | | | | | | PRICE PER INCH |
|------------------|------------------------------|-------------------------------|----------|--------------------|----------|----------|----------|--|
| | | | | | | | | ALWAYS USE NEXT EVEN INCH x PRICE OF EDGE WORK |
| | GLASS THICKNESS | | | | | | | |
| | 1/8" | 3/16" | 1/4" | 1/4" LAMI | 3/8" | 1/2" | 3/4" | |
| Seamed Edge | 0.052 | 0.052 | 0.052 | 0.052 | 0.116 | 0.154 | 0.218 | |
| Flat Polish Edge | 0.090 | 0.090 | 0.090 | 1.080 ¹ | 0.192 | 0.258 | 0.386 | |
| ½" Bevel | 0.179 | 0.129 | 0.129 | | 0.327 | 0.386 | 0.617 | |
| ¾" Bevel | | 0.166 | 0.166 | | 0.368 | 0.424 | 0.669 | |
| 1" Bevel | | 0.213 | 0.213 | | 0.415 | 0.476 | 0.758 | |
| 1 ¼" Bevel | | 0.258 | 0.258 | | 0.463 | 0.514 | 0.875 | |
| 1 ½" Bevel | | 0.348 NT | 0.348 NT | | 0.557 | 0.604 | 1.054 | |
| 2" Bevel NT | | | 1.157 NT | | 1.408 NT | 1.415 NT | 2.623 NT | |
| Double Bevel NT | | | Quote | | Quote | Quote | Quote | |
| Dual Bevel NT | | | | | Quote | Quote | Quote | |
| 0-45° Miter | | | 0.772 | | 0.901 | 1.093 | 1.428 | |
| Chamfer | | | | | 0.901 | 1.093 | 1.428 | |
| Pencil Polish | | Pencil Polish Minimum \$25.00 | 0.489 | | 0.553 | 0.630 | 1.093 | |

| TREATMENT | SHAPE / DIAMETER EDGE TREATMENT | | | | | | | PRICE PER INCH |
|------------------|---------------------------------|-------|----------|--------------------|-------|-------|-------|--|
| | | | | | | | | ALWAYS USE NEXT EVEN INCH x PRICE OF EDGE WORK |
| | GLASS THICKNESS | | | | | | | |
| | 1/8" | 3/16" | 1/4" | 1/4" LAMI | 3/8" | 1/2" | 3/4" | |
| Seamed Edge | 0.052 | 0.064 | 0.064 | 0.064 | 0.116 | 0.154 | 0.218 | |
| Flat Polish Edge | | 0.489 | 0.489 | 1.080 ¹ | 0.553 | 0.630 | 1.093 | |
| ½" Bevel | 0.914 | 0.914 | 0.914 | | 1.054 | 1.132 | 2.012 | |
| ¾" Bevel | | 0.990 | 0.990 | | 1.144 | 1.221 | 2.160 | |
| 1" Bevel | | 1.080 | 1.080 | | 1.221 | 1.299 | 2.341 | |
| 1 ¼" Bevel | | 1.144 | 1.144 | | 1.364 | 1.441 | 2.584 | |
| 1 ½" Bevel | | | 1.672 NT | | 1.826 | 1.891 | 3.485 | |
| Double Bevel NT | | | | | Quote | Quote | Quote | |
| Dual Bevel NT | | | | | Quote | Quote | Quote | |
| Pencil Polish | | | 0.489 | | 0.553 | 0.630 | 1.093 | |

| ADDITIONAL CHARGES | MINIMUM CHARGES |
|--|--|
| Polish 5 to 8 straight-sided pieces – Requires shapes polish | Straight Line Edge Work on Bevel Only – \$16.50 per order |
| Bevel 5 to 8 straight-sided pieces – Add 35% to order (Use straight line bevel charge) | Shape Edge Treatment – \$30.62 per piece |
| Special degree bevel – \$31.84 Setup plus per inch bevel | 2" Bevel – \$31.90 Setup Charge plus \$58.30 Edge Work minimum |
| Add 35% to Edge Treatment for customer supplied glass | |

NT - Not able to be tempered

¹ - Laminated requires minimum width of 4" in order to polish

See page 12 for profiles of edge treatments.

CORNERS, NOTCHES, HOLES

| CORNERS (per corner unless otherwise stated) | PRICE PER EACH | | | | | | |
|--|-----------------|-------|----------|-----------|----------|----------|----------|
| | GLASS THICKNESS | | | | | | |
| | 1/8" | 3/16" | 1/4" | 1/4" LAMI | 3/8" | 1/2" | 3/4" |
| Flat (or Pencil) Polish Radius Corner up to 10" (Max 4 corners per piece) | Setup | 11.02 | 11.02 | | 19.60 | 26.94 | 39.19 |
| Add one (1) Setup Charge for up to (4) corners plus Shape Edge Treatment (per inch) for entire perimeter | Shape Edge | 0.489 | 0.489 | | 0.553 | 0.630 | 1.093 |
| 1" Bevel (Illustration on page13) | | | 20.17 | | 20.17 | 26.95 | 53.89 |
| 1 1/2" Bevel (Illustration on page13) | | | 20.17 NT | | 20.17 | 26.95 | 53.89 |
| 1", 1 1/2" Beveled Radius Corner NT (Illustration on page 13) | | | 53.89 NT | | 53.89 NT | 60.65 NT | 87.48 NT |
| Bump Corners | | 1.340 | 1.340 | 3.330 | 3.330 | 6.710 | 9.800 |
| HOLES - (COUNTERSINK HOLES (up to 1 1/2" diameter countersink) - HOLE PRICING 2X) | | | | | | | |
| 1/8", 3/16", 1/4", 5/16", 3/8", 7/16", 1/2", 9/16", 5/8", 3/4" | 4.32 | 4.32 | 4.32 | Quote | 7.34 | 9.80 | 33.65 |
| 1", 1 1/16", 1 3/16", 1 1/4", 1 1/2", 1 5/8", 1 3/4", 2", 2 1/4", 2 1/2" | 6.76 | 6.76 | 6.76 | Quote | 21.41 | 21.41 | 42.87 |
| 3", 3 1/2", 4" | 20.17 | 20.17 | 20.17 | Quote | 40.41 | 40.41 | 67.36 |
| 4 1/4" and up - CNC (\$40 minimum) | | | | | | | |
| SWITCHES OR OUTLETS – DRILLED NON-FINISHED INTERIOR EDGE | | | | | | | |
| Single (Std. Size - 2 1/4" x 4 1/2") | | 21.17 | 21.17 | | | | |
| Double (Std. Size - 4 1/4" x 4 1/2") | | 42.45 | 42.45 | | | | |
| Triple (Std. Size - 6 1/4" x 4 1/2") | | 63.69 | 63.69 | | | | |
| Quad (Std. Size - 8" x 4 1/2") | | 84.86 | 84.86 | | | | |
| NOTCHES – MILLED SATIN ARIS EDGE // ALL NOTCHES HAVE 3/8" RADIUS (MINIMUM) | | | | | | | |
| Edge/Corner – Minimum Charge up to 30 U.I. Replaces Edge Notch (Hinge Notch) | | 31.84 | 31.84 | Quote | 40.12 | 41.85 | 66.14 |
| Edge/Corner – >30 U.I. to 100 U.I. (per inch) | | 1.103 | 1.103 | Quote | 1.543 | 1.739 | 2.254 |
| Edge/Corner – >100 U.I. | | Quote | Quote | Quote | Quote | Quote | Quote |
| SANDBLASTED PLATE RAIL – \$30.62 Setup Charge per piece + \$2.04 per inch | | | | | | | |
| V-GROOVE – Please fax drawings for quote | | | | | | | |
| ETCHED FINGER PULL – \$41.50 - Standard Size 5/8" x 2 3/4" | | | | | | | |

OUT OF SQUARE DRAWING REQUIREMENTS

All dimensions provided are to be centerline dimensions.
Ensure all out-conditions add-up before placing order.

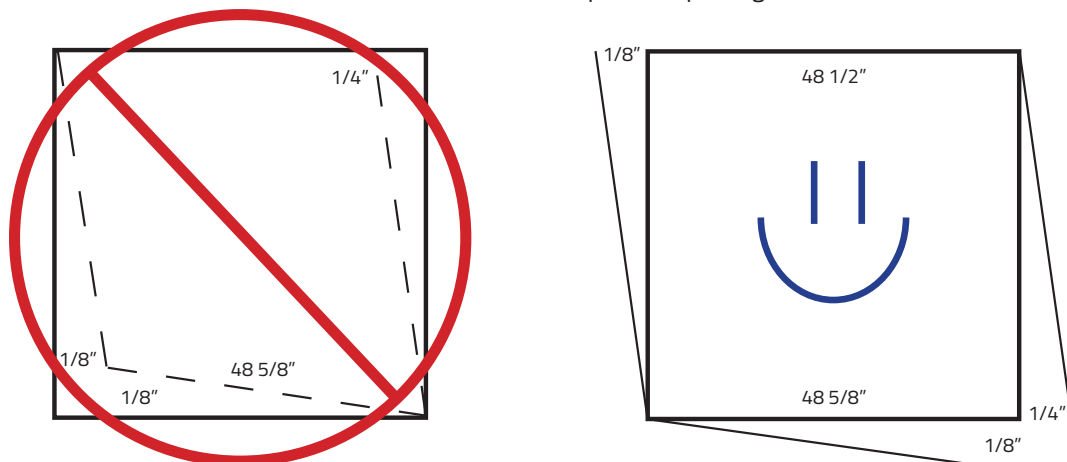

PATTERNS

PATTERN CHARGES –

| | PATTERN CHARGE |
|--|----------------|
| Diameter Patterns on 3/8" & 1/2" | 23.00 |
| Diameter Patterns on 3/4" & Lami | 40.00 |
| Patterns for thicknesses on glass \leq 3/16" with a seamed edge | 23.00 |
| Patterns on all other glass thicknesses with a seamed edge & Patterns on all glass thicknesses with a polished or beveled edge | 50.00 |
| Patterns on laminated glass | 65.00 |

Even if quoted without - if a physical pattern is sent to WSD; the pattern charge will be added.

ADDITIONAL CHARGES - 5-8 sided patterns require shapes polishing.

BLOCK SIZE CALCULATIONS – Additional material is required during the fabrication process to create a quality pattern. Use the following table to find your glass thickness and add the listed measurement to each dimension to determine the correct block size needed for your pattern.

| THICKNESS | ADD TO EACH DIMENSION |
|-----------|-----------------------|
| 1/8" | |
| 3/16" | 2" |
| 1/4" | |
| 3/8" | 4" |
| 1/2" | |
| 3/4" | 6" |

CUTOUTS – Customers are responsible for cutting out patterns. A full size pattern is require for shapes other than squares, rectangles & diameters. If WSD cuts out pattern, we are not responsible for final fit. Tolerances (see pg 7) still apply to all patterns.

DIAMETERS - Diameters/Patio Tables of 38" or greater on 3/16" & 1/4" pattern glass will be charged for a full stock sheet of pattern glass at cut-to-size pricing.

MATERIAL – Reference the following chart for acceptable pattern materials. WSD will return all patterns submitted on unacceptable materials.

| ACCEPTABLE | UNACCEPTABLE |
|---------------------|-------------------|
| Luan | Tissue Paper |
| Masonite | Wrapping Paper |
| White Butcher Paper | Brown Kraft Paper |
| Glass | Broken Glass |
| Cardboard | Rosin Paper |
| | Newspaper |

PATTERN MATCHING - WSD will match the submitted pattern; not dimensions. **Submitted patterns must specify viewing from smooth or textured surface.**

QUALITY – The quality of the pattern that you send to WSD directly impacts the quality of the finished goods.

TEMPERING LIMITATIONS

HOLES AND NOTCHES – This chart should be used to determine minimum sizes and placement of holes and notches in tempered glass:

| GLASS THICKNESS (t) | 1/8" | 3/16" | 1/4" | 3/8" | 1/2" | GENERAL RULE |
|---|--------|---------|--------|---------|--------|------------------------|
| Minimum Diameter of Holes (A) | 1/4" | 1/4" | 1/4" | 3/8" | 1/2" | $A \geq t$ |
| Distance from Hole Rim to Edge of glass (B) | 1/4" | 3/8" | 3/8" | 9/16" | 3/4" | $B \geq 1.5t$ |
| Distance between rims of holes (C) | 3/8" | 3/8" | 1/2" | 3/4" | 1" | $C \geq 2t$ and $3/8"$ |
| Distance from Corner to Rim of Hole (E) | 13/16" | 1 7/32" | 1 5/8" | 2 7/16" | 3 1/4" | $E \geq 6.5 \times t$ |
| Minimum Fillet Radius (F) | 3/8" | 3/8" | 3/8" | 3/8" | 3/8" | |

- Countersink holes require technical review and approval before order acceptance.
- Large holes and notches greater than 1/3 the narrow dimension require technical review and approval.

HOLE AND NOTCH LOCATION TOLERANCES

- For dimensions of hole center from specified edge $\pm 1/16"$
- For dimensions between hole centers $\pm 1/16"$
- Chips and flakes will not exceed $1/16"$
- Notch dimensions for glass 1/4" and under $\pm 1/16"$
- Notch dimensions for 3/8" and 1/2" $\pm 1/8"$

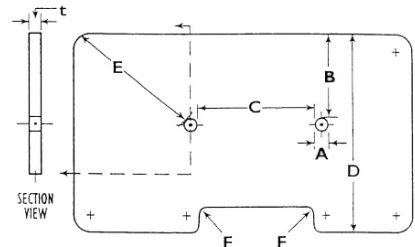

TEMPERED SIZE RANGE – Three (3) square foot minimum, odd or fractional dimensions will be billed at the next higher even inch.

| THICKNESS | MINIMUM SIZE | MAXIMUM SIZE | GLASS SIZE TOLERANCE |
|---|--------------|--------------|---------------------------------------|
| 1/8" | 5" x 11" | 32" x 74" | |
| 3/16" | | 72" x 120" | $\pm 1/16"$ |
| 1/4" | 3" x 11" | 84" x 130" | |
| 3/8" - 1/2" | | | $\pm 1/8"$ |
| Glass over 120" add 75% to appropriate square foot price | | | Hold to exact size - Add 20% to order |

EDGE TREATMENT – Tempered glass has seamed edges unless ordered with polished edges. The seamed edge is not a suitable exposed finished edge. 1/2" tempered glass requires satin polished edge (charges apply).

TEMPERED CERTIFICATION LOGO – Tempered glass is permanently labeled unless ordered "NO LOGO".

DISTORTION – Heat treating adds distortion to glass products. All requirements for distortion, roller wave, consistent furnace orientation or distortion measurement must be disclosed at quotation and order.

STRAIN PATTERN - Tempered glass contains a strain pattern or "Quench Marks" that appear as areas of shadows in a pattern corresponding to the location of air nozzles in the tempering furnace quench section. This condition becomes more visible:

- Under certain lighting conditions, like polarized sunlight
- When the glass is viewed at glancing angles
- With tinted glass, especially when multiple lites are combined in laminated and insulating constructions

The strain pattern is not considered a defect in tempered glass products.

SPONTANEOUS BREAKAGE – Tempered glass is subject to rare spontaneous breakage, where the glass will break for no apparent reason.

INSTALLATION - Monolithic low light transmitting glass (i.e. Midnight Grey, Low-E, 3/8" and 1/2" Bronze and Grey) should be glazed with a consistent tin side/ air side orientation.

CRATING -WSD no longer offers crating as a delivery option.

FABRICATION – All fabrication that penetrates the glass surface (i.e. holes, notches, sand blasting, cutting) must take place prior to tempering.

GLASS QUALITY - All tempered glass shall conform to Consumer Product Safety Commission (CPSC) Standard 16 CFR 1201.

CERTIFICATE OF TEMPERING - Certificate of tempering are available upon request.

CANCELLATIONS - If manufacturing has started on an order and changes or cancellation occurs, the customer will be shipped the raw glass and billed for the same.

EDGE WORK PROFILES

EDGEWORK INCLUDES HIGH POLISH EXCEPT AS NOTED*

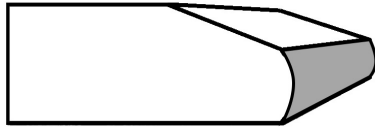

Beveled Edge*

Available on 1/8", 1/4", 3/8", 1/2", 3/4" glass thickness

*Satin Edge

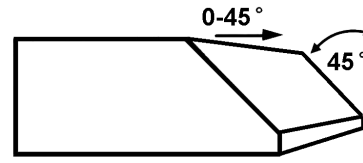

0-45° Miter Edge

Available on 1/4", 3/8", 1/2", 3/4" glass thickness

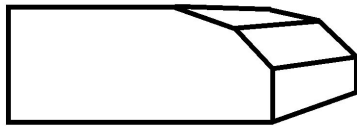

Double Beveled Edge

Available on 1/4", 3/8", 1/2", 3/4" glass thickness

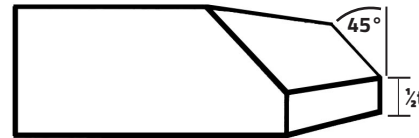

Chamfer Edge

Available on 3/8", 1/2", 3/4" glass thickness

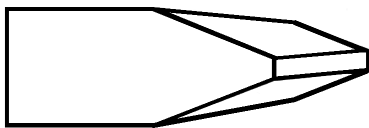

Dual Beveled Edge

Available on 3/8", 1/2", 3/4" glass thickness



Pencil Polish Edge

Available on 1/4", 3/8", 1/2", 3/4" glass thickness



Flat Polish Edge

Available on 3/16", 1/4", 3/8", 1/2", 3/4" glass thickness

BEVELED STRAIGHT LINE ILLUS.

1" straight line bevel with 1-1/4" radius corner to retain 1" bevel at radius corner.

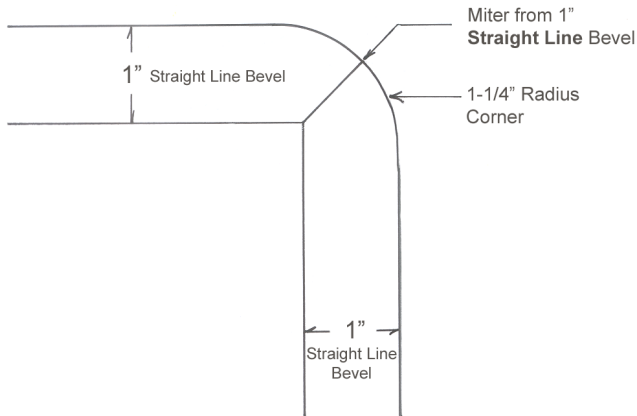

1-1/2" straight line bevel with 1-3/4" radius corner to retain 1-1/2" bevel at radius corner.

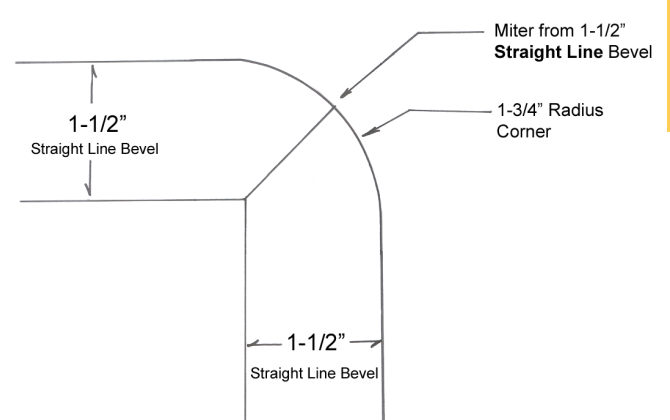

FABRICATION

BEVELED RADIUS CORNER ILLUS.

1" or 1-1/2" beveled radius corner - minimum 2" radius on outside corner.

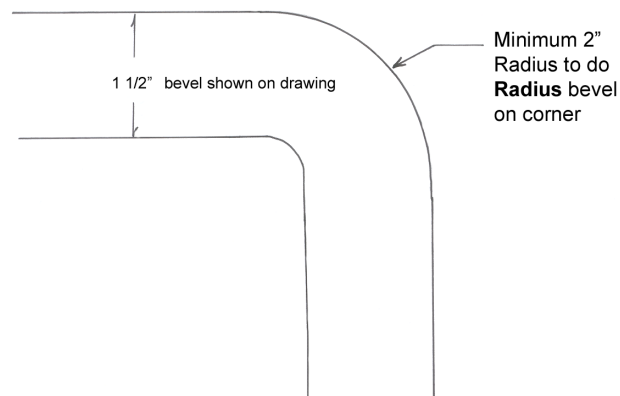

SHAPES

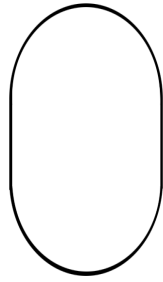

Race Track

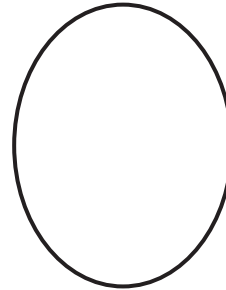

Oval/Elliptical

Requires a pattern



Queen Anne

Requires a pattern

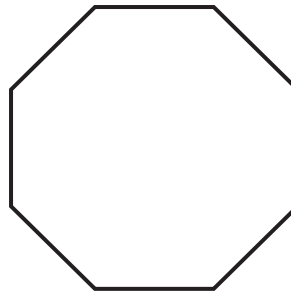

Octagon

Measure flat to flat or requires a pattern

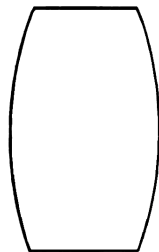

Boat

Requires a pattern

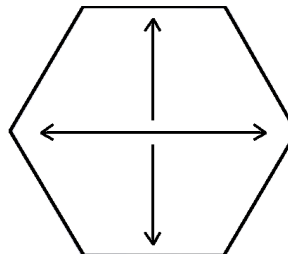

Hexagon

Measure point to point and flat to flat or requires a pattern

FORMULAS FOR CALCULATING INCHES ON SHAPES

| | |
|-------------------------|------------------------|
| Radius Top | Width x 1.6 |
| Ovals (Ellipticals) | (Length + Width) x 1.7 |
| Circle | Diameter x 3.14 |
| Octagon (8 equal sides) | Width x 3.4 |
| Hexagon (6 equal sides) | Width x 3 |

STOCK TEMPERED - DOOR BLANKS

DOOR BLANK SIZE

| | 28" x 71 1/2" | 28" x 75 1/2" | 28" x 79 1/2" |
|-----------------------------|---------------|---------------|---------------|
| 3/8" Clear Glass Door Blank | 197.00 | 204.00 | 212.00 |

Door Blank Features: 3/8" clear glass, polished on all edges, 8" CTC 1/2" holes for handles and 2 notches for hinges

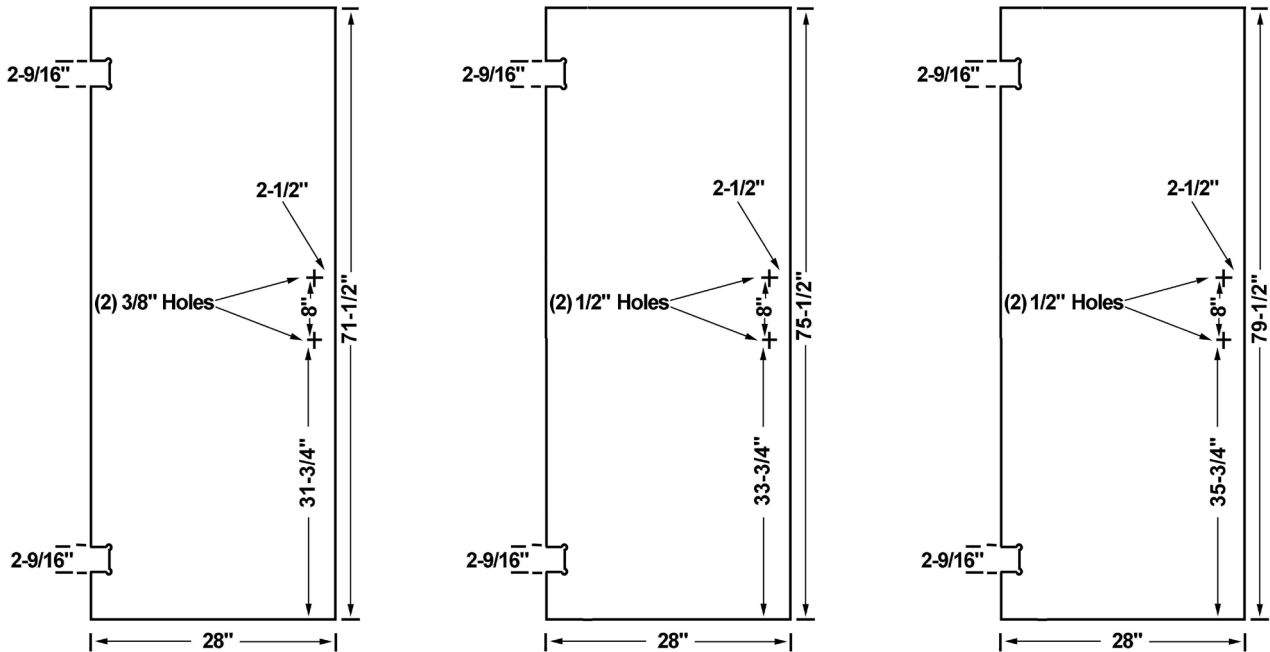

TEMPERED

STANDARD DOOR HEIGHTS FOR HEAVY GLASS STANDARD HINGE DOOR BLANKS

| | OVERALL HEIGHT | OVERALL HEIGHT WITH A SC-915 CURB |
|----------------|----------------|-----------------------------------|
| 28" x 71 1/2" | | |
| Stand alone | 72" | 72 7/16" |
| SC-646 Header | 73 7/8" | 74 5/16" |
| Horizon Header | 73 1/2" | 73 15/16" |
| 28" x 75 1/2" | | |
| Stand alone | 76" | 76 7/16" |
| SC-646 Header | 77 7/8" | 78 5/16" |
| Horizon Header | 77 1/2" | 77 15/16" |
| 28" x 79 1/2" | | |
| Stand alone | 80" | 80 7/16" |
| SC-646 Header | 81 7/8" | 82 5/16" |
| Horizon Header | 81 1/2" | 81 15/16" |

STANDARD DOOR HEIGHTS FOR HEAVY GLASS PIVOT HINGE DOOR BLANKS

| | OVERALL HEIGHT | OVERALL HEIGHT WITH A SC-915 CURB |
|----------------|----------------|-----------------------------------|
| 28" x 71 1/2" | | |
| Stand alone | 72" | 72 7/16" |
| SC-646 Header | 74" | 74 7/16" |
| Horizon Header | 73 1/2" | 73 15/16" |
| 28" x 75 1/2" | | |
| Stand alone | 76" | 76 7/16" |
| SC-646 Header | 78" | 78 7/16" |
| Horizon Header | 77 1/2" | 77 15/16" |
| 28" x 79 1/2" | | |
| Stand alone | 80" | 80 7/16" |
| SC-646 Header | 82" | 82 7/16" |
| Horizon Header | 81 1/2" | 81 15/16" |

WALL TO GLASS HINGES

| HINGE | FINISH | DOOR BLANK SIZE | | |
|------------------|----------------------------|-----------------|---------------|---------------|
| | | 28" x 71 1/2" | 28" x 75 1/2" | 28" x 79 1/2" |
| Premier Package | Chrome | 299.00 | 306.00 | 314.00 |
| | Brushed Nickel | 296.00 | 303.00 | 311.00 |
| | Oil Rubbed Bronze (dark) | 309.00 | 316.00 | 324.00 |
| Symphony Package | Chrome | 298.00 | 305.00 | 313.00 |
| | Brushed Nickel | 298.00 | 305.00 | 313.00 |
| | Oil Rubbed Bronze (medium) | 314.00 | 321.00 | 329.00 |

Each package will include a door blank (3/8" clear glass, polished on all edges, 8" CTC 1/2" holes for handles and 2 notches for hinges), 2 hinges and an 8" back to back C-Pull. Packages DO NOT include polycarbonate components. PLEASE SPECIFY YOUR CHOICE OF 0° OR 5° PIN ON YOUR ORDER.

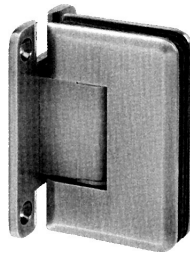

US Horizon Premier Hinge
Wall to Glass hinge with full plate.
Available in 0° or 5° load



Portals Symphony Hinge
Wall to Glass with full plate.
Available in 0° or 5° load.

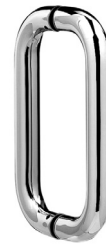

8" Back to Back C-Pull

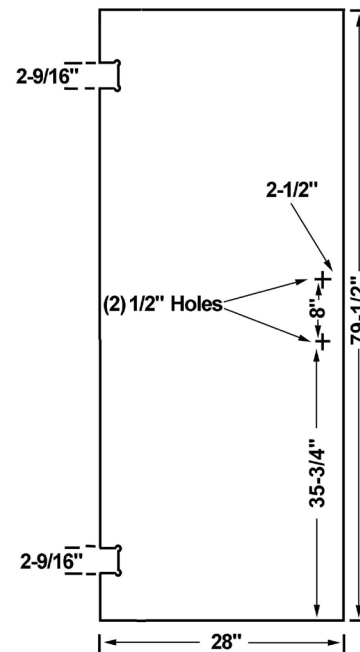
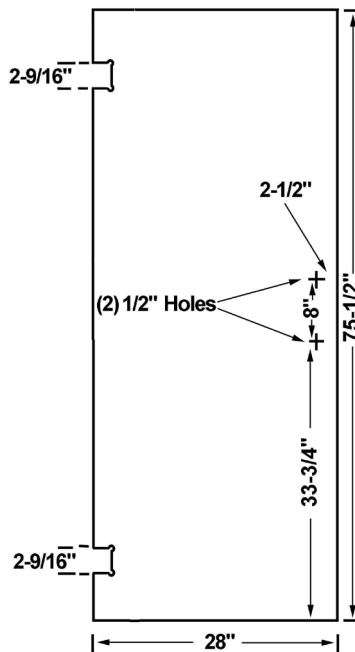
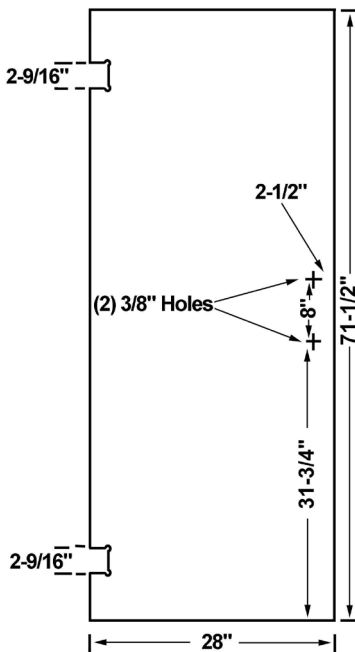

TEMPERED

180° GLASS TO GLASS HINGES

| HINGE | FINISH | DOOR BLANK SIZE | | |
|------------------|----------------------------|-----------------|---------------|---------------|
| | | 28" x 71 1/2" | 28" x 75 1/2" | 28" x 79 1/2" |
| Premier Package | Chrome | 350.00 | 357.00 | 365.00 |
| | Brushed Nickel | 366.00 | 373.00 | 381.00 |
| | Oil Rubbed Bronze (dark) | 370.00 | 377.00 | 385.00 |
| Symphony Package | Chrome | 373.00 | 380.00 | 388.00 |
| | Brushed Nickel | 336.00 | 343.00 | 351.00 |
| | Oil Rubbed Bronze (medium) | 435.00 | 442.00 | 450.00 |

Each package will include a door blank (3/8" clear glass, polished on all edges, 8" CTC 1/2" holes for handles and 2 notches for hinges), 2 hinges and an 8" back to back C-Pull. Packages DO NOT include polycarbonate components. PLEASE SPECIFY YOUR CHOICE OF 0° OR 5° PIN ON YOUR ORDER.

TEMPERED



US Horizon Premier Hinge
180° Glass to Glass hinge.
Available in 0° or 5° load



Portals Symphony Hinge
180° Glass to Glass hinge.
Available in 0° or 5° load.

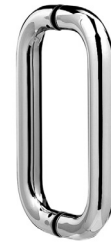

8" Back to Back C-Pull

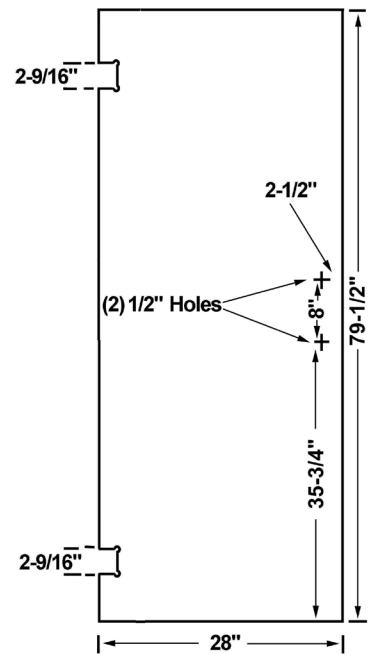
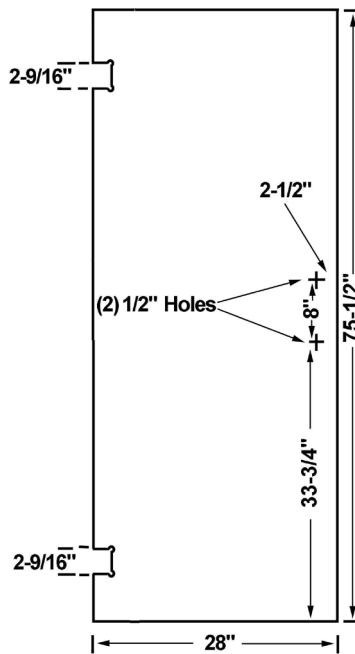
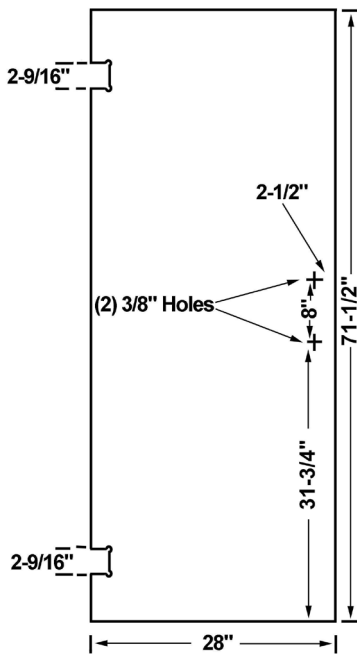

PIVOT HINGES

| HINGE | FINISH | DOOR BLANK SIZE | | |
|------------------|--------------------------|-----------------|---------------|-------------|
| | | 28" x 71 1/2" | 28" x 75 1/2" | 28" 79 1/2" |
| Montreal Package | Chrome | 375.00 | 381.00 | 388.00 |
| | Brushed Nickel | 323.00 | 329.00 | 336.00 |
| | Oil Rubbed Bronze (dark) | 338.00 | 344.00 | 351.00 |

Each package will include a door blank (3/8" clear glass, polished on all edges, 8" CTC 1/2" holes for handles and 2 notches for hinges), 2 pivot hinges and an 8" back to back C-Pull. **Packages DO NOT include polycarbonate components.** PLEASE SPECIFY YOUR CHOICE OF 0° OR 5° PIN ON YOUR ORDER.

TEMPERED



US Horizon Montreal Hinge
Beveled pivot hinge, ceiling or curb mount.

8" Back to Back C-Pull

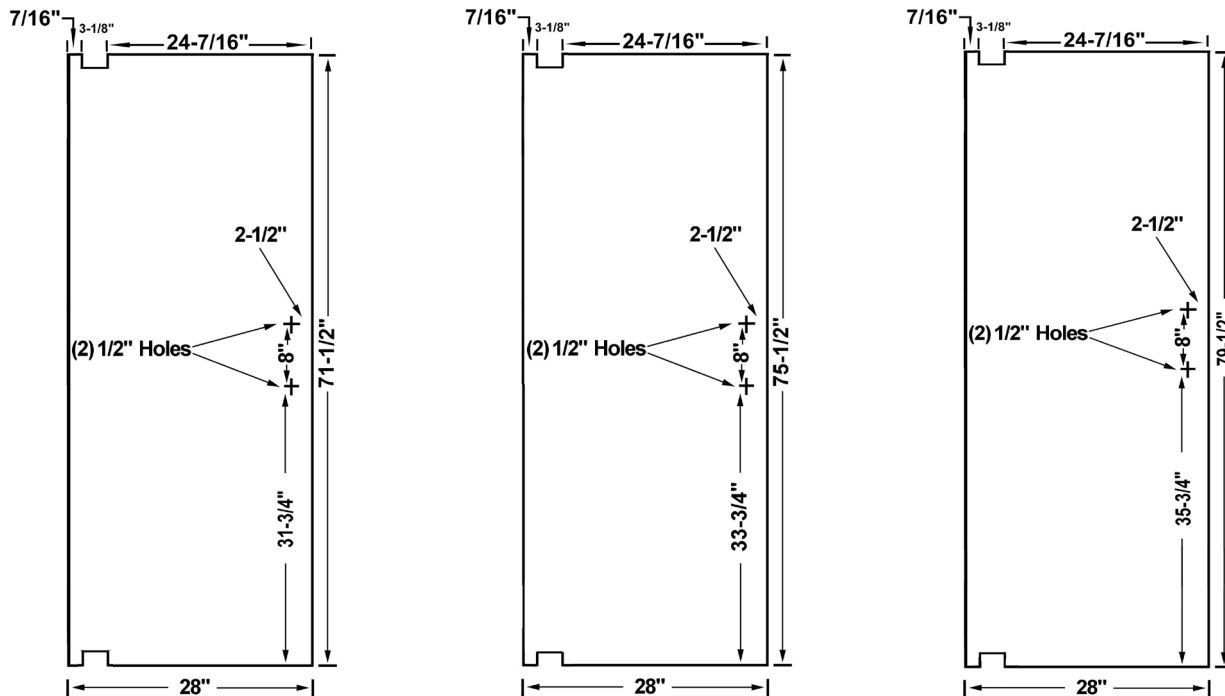

STANDARD SIZE MIRRORS

**NON-STOCK ITEMS
STANDARD FABRICATION &
DELIVERY TIMES APPLY**

| STANDARD SIZES | POLISHED | | | 1/2" BEVEL | | | 1" BEVEL | | |
|----------------|----------------|--------|-------|----------------|--------|--------|----------------|--------|--------|
| | VOLUME PRICING | | | VOLUME PRICING | | | VOLUME PRICING | | |
| | 1-24 | 25-49 | 50+ | 1-24 | 25-49 | 50+ | 1-24 | 25-49 | 50+ |
| 24" x 30" | 29.33 | 28.10 | 26.63 | 32.18 | 30.82 | 29.21 | 38.30 | 36.69 | 34.78 |
| 24" x 36" | 34.61 | 33.15 | 31.43 | 37.77 | 36.18 | 34.30 | 44.58 | 42.71 | 40.48 |
| 30" x 36" | 42.17 | 40.39 | 38.29 | 45.65 | 43.73 | 41.45 | 53.14 | 50.90 | 48.25 |
| 36" x 36" | 49.72 | 47.63 | 45.15 | 53.52 | 51.27 | 48.59 | 61.69 | 59.10 | 56.01 |
| 42" x 36" | 57.28 | 54.87 | 52.01 | 61.39 | 58.81 | 55.74 | 70.25 | 67.29 | 63.78 |
| 48" x 36" | 64.84 | 62.11 | 58.87 | 69.26 | 66.35 | 62.89 | 78.80 | 75.48 | 71.55 |
| 54" x 36" | 72.39 | 69.35 | 65.73 | 77.14 | 73.89 | 70.04 | 87.35 | 83.68 | 79.32 |
| 60" x 36" | 79.95 | 76.59 | 72.59 | 85.01 | 81.43 | 77.19 | 95.91 | 91.87 | 87.08 |
| 66" x 36" | 87.51 | 83.83 | 79.46 | 92.88 | 88.98 | 84.34 | 104.46 | 100.07 | 94.85 |
| 72" x 36" | 95.06 | 91.07 | 86.32 | 100.76 | 96.52 | 91.48 | 113.02 | 108.26 | 102.62 |
| 24" x 40" | 38.13 | 36.53 | 34.62 | 41.50 | 39.76 | 37.69 | 48.77 | 46.72 | 44.28 |
| 30" x 40" | 46.45 | 44.49 | 42.17 | 50.14 | 48.03 | 45.52 | 58.08 | 55.64 | 52.74 |
| 36" x 40" | 54.76 | 52.46 | 49.72 | 58.77 | 56.29 | 53.36 | 67.39 | 64.56 | 61.19 |
| 42" x 40" | 63.08 | 60.42 | 57.27 | 67.40 | 64.56 | 61.20 | 76.71 | 73.48 | 69.65 |
| 48" x 40" | 71.39 | 68.39 | 64.82 | 76.03 | 72.83 | 69.03 | 86.02 | 82.40 | 78.10 |
| 54" x 40" | 79.71 | 76.35 | 72.37 | 84.66 | 81.10 | 76.87 | 95.33 | 91.32 | 86.56 |
| 60" x 40" | 88.02 | 84.32 | 79.92 | 93.29 | 89.37 | 84.71 | 104.64 | 100.24 | 95.02 |
| 66" x 40" | 96.34 | 92.29 | 87.47 | 101.92 | 97.64 | 92.55 | 113.96 | 109.16 | 103.47 |
| 72" x 40" | 104.65 | 100.25 | 95.02 | 110.56 | 105.91 | 100.38 | 123.27 | 118.08 | 111.93 |
| 24" x 42" | 39.89 | 38.21 | 36.22 | 43.37 | 41.55 | 39.38 | 50.86 | 48.72 | 46.18 |
| 30" x 42" | 48.59 | 46.54 | 44.12 | 52.38 | 50.18 | 47.56 | 60.55 | 58.01 | 54.98 |
| 42" x 42" | 65.98 | 63.20 | 59.90 | 70.40 | 67.44 | 63.92 | 79.94 | 76.57 | 72.58 |
| 48" x 42" | 74.67 | 71.53 | 67.80 | 79.41 | 76.07 | 72.11 | 89.63 | 85.86 | 81.38 |
| 54" x 42" | 83.36 | 79.86 | 75.69 | 88.42 | 84.70 | 80.29 | 99.32 | 95.14 | 90.18 |
| 60" x 42" | 92.06 | 88.19 | 83.59 | 97.43 | 93.34 | 88.47 | 109.01 | 104.43 | 98.98 |
| 66" x 42" | 100.75 | 96.52 | 91.48 | 106.45 | 101.97 | 96.65 | 118.70 | 113.71 | 107.78 |
| 72" x 42" | 109.45 | 104.84 | 99.38 | 115.46 | 110.60 | 104.83 | 128.40 | 123.00 | 116.58 |

FRAMELESS

Standard Size Mirrors Tolerance - ±1/4"

Boxing charge for Standard Size Mirrors & Door Mirrors: Up to 42" – \$9.00 // For 48" up to 72" – \$12.50

DOOR MIRRORS

**NON-STOCK ITEMS
STANDARD FABRICATION &
DELIVERY TIMES APPLY**

| STANDARD SIZES | | FLAT POLISH | 1/2" BEVEL |
|----------------|-------------------|-------------|------------|
| 16" x 68" | 1/4" Clear Mirror | 42.87 | 47.13 |
| 18" x 68" | 1/4" Clear Mirror | 47.24 | 51.59 |
| 20" x 68" | 1/4" Clear Mirror | 51.60 | 56.06 |
| 22" x 68" | 1/4" Clear Mirror | 55.97 | 60.52 |
| 24" x 68" | 1/4" Clear Mirror | 60.33 | 64.99 |

Boxing charge for Standard Size Mirrors & Door Mirrors: Up to 42" – \$9.00 // For 48" up to 72" – \$12.50

FRAMELESS

IMPORTED FRAMELESS SHAPES*

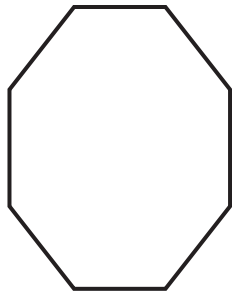

| OCTAGON | | 1" BEVEL |
|-----------|--------------------|----------|
| 22" x 28" | 3/16" Clear Mirror | 51.11 |
| 24" x 36" | 3/16" Clear Mirror | 62.06 |

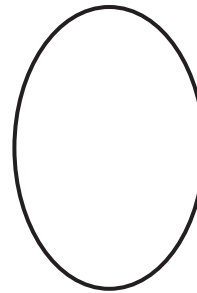

| OVAL | | 1" BEVEL |
|-----------|--------------------|----------|
| 21" x 31" | 3/16" Clear Mirror | 57.80 |
| 24" x 37" | 3/16" Clear Mirror | 69.27 |

Imported Frameless Shapes include backer with individual carton

*Imported Frameless Shapes are sold "as-is". These are not custom mirrors and are not held to normal industry specifications.

I.G. UNIT FABRICATION

| PRICE PER SQUARE FOOT | | | | | | |
|-----------------------|-----------------------|----------|----------|-------------------------------|----------|----------------------------|
| GLASS | | ANNEALED | TEMPERED | LOW – E (Energy Advantage) | | LOW-E (7036 ClimaGuard) |
| | | | | ANNEALED | TEMPERED | ANNEALED |
| SS | Clear | 6.88 | | | | 10.40 |
| DS | Clear | 6.88 | 9.52 | 10.00 | 12.64 | 10.40 |
| 3/16" | Clear | 7.89 | 10.94 | 11.80 | 14.11 | 12.74 |
| 1/4" | Clear | 8.35 | 11.27 | | | |
| DS | Bronze/Grey | 9.33 | 13.57 | 11.96 | 15.47 | 12.35 |
| 3/16" | Bronze/Grey | 10.31 | 13.74 | 14.16 | 15.85 | 15.10 |
| 1/4" | Bronze/Grey | 10.72 | 14.14 | | | |
| 1/8" | Pattern #62 | 10.48 | 12.80 | | | |
| 3/16" | Aquatex | 12.87 | 14.69 | | | |
| 1/4" | .030 Clear Laminated | 24.09 | | | | |
| DS | Clear Patio 34" x 76" | | 101.49 | | 133.16 | |
| 5/32" | Clear Patio 46" x 76" | | 145.92 | | 210.06 | |

SPECIAL SHAPES AND COMBINATIONS

| | |
|---|---|
| Archtops | add 60% |
| Octagons | add 70% |
| Rectangle Grids (flat muntins avail in 5/8" & 3/4") | add \$3.60 per divided lite (available in green, bronze, champagne, beige, tan, white) |
| Contour Grids (see page 25) | add \$3.60 per divided lite (available in tan and white) |
| Trapezoids & Triangles | add 30% |
| Triple Glazed | add 65% |
| Argon for annealed and tempered units | add \$0.30 per sq. ft.; minimum order of \$3.00 |

Maximum area for thickness of glass:

DS (1/8") glass – 16 square feet // 3/16" glass – 35 square feet // 1/4" glass – 42 square feet // Tempered Glass required after 42 square feet

Units over 50 square feet are subject to special pricing.

There is no warranty on units over 50 square feet.

Odd or fractional dimensions will be billed at next even inch.

If manufacturing has been started on an order, and changes or cancellation occur, the customer will be shipped the raw glass and billed for the same.

All prices based on three (3) square foot minimum per unit.

INSULATED GLASS ORDER REQUESTS - SEND TO:

- igorders@wisconsinshowerdoor.com
- Fax to: 888.329.5196

Wisconsin Shower Door
I.G. Unit Fabrication
5803 Packer Drive
Wausau, WI 54401

P: 888.329.5194
F: 888.329.5196

CONTOUR MUNTIN – IN-LINE CLIP

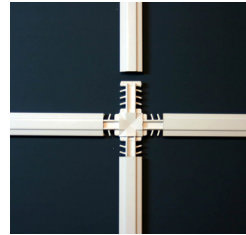

The muntins slide onto the in-line muntin clip.

CONTOUR MUNTIN – SNAP OVER CLIP

INSUL GLASS

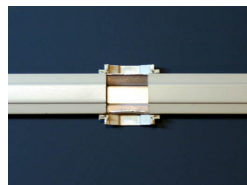
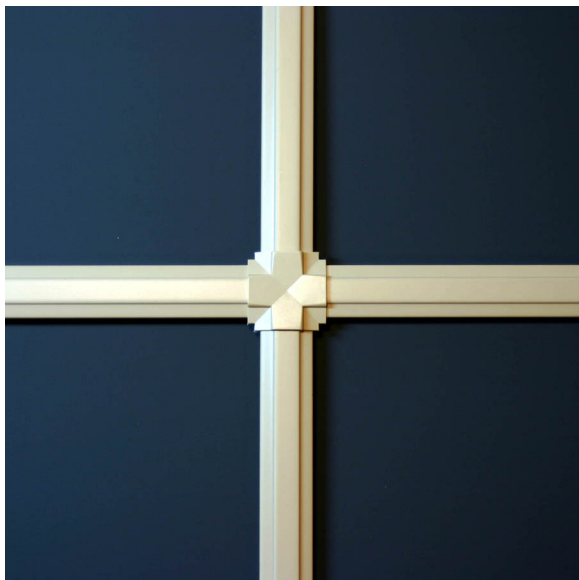

One muntin is cut. One side of a snap over clip is placed at the intersection of the muntins.



The next muntin is placed over the clip and pre-cut muntin.



The second side of the snap over clip is put into place and snapped together

I.G. DOOR UNITS

INSULATED GLASS DOOR UNITS FOR COMMERCIAL ENTRANCES

TUBELITE DOORLITES

30 9/16" x 76 1/16" x 1" OA

73.83

FOAMTITE STORM WINDOWS

FOAMTITE INTERIOR STORM WINDOWS

| UNITED INCHES | GLASS | |
|---------------|--------|--------|
| | SS | DS |
| 0-40 | 61.82 | |
| 41-50 | 71.15 | |
| 51-60 | 80.70 | |
| 61-70 | 90.45 | |
| 71-80 | 100.42 | |
| 81-90 | 110.61 | |
| 91-100 | | 125.41 |
| 101-110 | | 136.74 |
| 111-120 | | 148.34 |

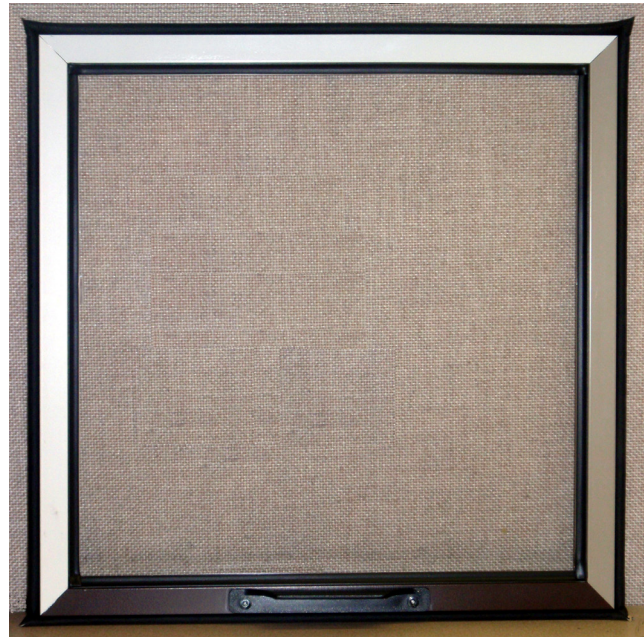

INSUL GLASS

Helps reduce condensation.

Effective against damaging moisture on wood areas with finishes applied.

Replaces applying plastic on windows annually.

Fits in area used by window screen (operating windows).

Can be used with stationary units and other types of windows.

One (1) lift handle (black only) applied for easy handling.

Available in five colors:

- Bronze
- Driftwood
- White
- Mocha
- Green

With black Foamtite weatherstripping.

Extruded aluminum frame.

I.G. UNIT LIMITED WARRANTY

For a period of ten (10) years from the date of purchase, Wisconsin Shower Door warranty is as follows: will not develop material obstruction of vision (on internal glass surfaces) as a result of dust or film formation caused by failure of hermetic seal. Glass is not warranted against breakage.

Precondition of this warranty is that all insulating glass units be installed in accordance to FGMA glazing manual standards and practices. Furthermore, all units must be installed in such manner as to completely repel water for the entire period of the warranty by use of approved sealants only.

This warranty does not apply to insulating glass units used in vehicles, commercial refrigeration, marine, swimming pool enclosures, greenhouses, airports, sloped applications, and skylights. **This warranty also does not apply to units manufactured with SuperSpacer.** We assume no responsibility for any damage due to thermal breakage or improper use or handling.

This warranty is made to our immediate customer only and all liability shall be limited to replacement of failed unit or refund of the original purchase price. No employee, dealer or agent for Wisconsin Shower Door is authorized to add or modify this warranty.

This warranty is the only warranty made, and it is made expressly in lieu of all other warranties and under no circumstances whatsoever shall we be liable in any way for incidental or consequential damages of any kind with regard to our product.

I.G. UNIT PERFORMANCE CHART

| I.G. UNIT GLASS TYPE | % OF VISIBLE LIGHT TRANSMITTANCE | SOLAR HEAT GAIN COEFFICIENT | FADING TRANSMISSION | WINTER U-VALUE AIR / ARGON |
|---|----------------------------------|-----------------------------|---------------------|----------------------------|
| Clear/Clear | 81 | .76 | .59 | .49 / .47 |
| Clear/Pilkington Energy Advantage (Low E) | 77 | .75 | .49 | .33 / .28 |
| Clear/Guardian 7036 ClimaGuard (Low E) | 71 | .38 | .33 | .29 / .24 |

INSUL GLASS

VISIBLE LIGHT TRANSMITTANCE – The percentage of visible light (390 to 700 nanometers) within the solar spectrum that is transmitted through the glass.

SOLAR HEAT GAIN COEFFICIENT – The amount of solar radiation that enters the building as heat. The lower the number, the better the glazing is at preventing solar gain.

FADING TRANSMISSION – The portion of energy transmitted in a special region from 300 to 600 nanometers. This region includes all of the ultraviolet energy and part of the visible spectrum, and will give the best representation of relative fading rates. The lower the number, the better the glass is for reducing fading potential of interior furnishings.

U-VALUE – This represents the heat flow rate through a window expressed in BTU/HR/TR2/°F, using winter weather conditions of 0°F outside and 70°F inside. The lower the number, the better the window system is at reducing heat loss.

A

| | |
|----------------------------------|----|
| ACI-15 Deep "J" Molding | 26 |
| ACI-21 Shallow "J" Molding | 26 |
| ACI-26 L-Bar | 26 |
| ACI-29 Face Strip | 26 |
| ACI-30 End Cap | 26 |
| ACI-51 Little Lip | 26 |

B

| | |
|---|----|
| Bruce's Glass Stain Remover | 28 |
| Buytl Glazing Tape 1/8" x 1/2" x 30" | 28 |
| Buytl Glazing Tape 1/16" x 1/2" x 45" | 28 |

C

| | |
|-----------------------------|----|
| ClearShield AfterCare | 28 |
|-----------------------------|----|

D

| | |
|-------------------------------------|----|
| Deep Shoe | 29 |
| Door Pull Assembly - Standard | 29 |
| Double Channel - 9/16" | 29 |
| Double Track | 29 |
| Dow Corning 786 | 28 |

G

| | |
|---|----|
| Glazing Vinyl - 1/4" | 29 |
| GMP 2C - Single Outlet | 27 |
| GMP 3C - Single Switch | 27 |
| GMP 6C - Double Outlet | 27 |
| GMP 7C - Outlet / Switch | 27 |
| GMP 8C - Double Switch | 27 |
| GMP 9C - Triple Switch | 27 |
| GMP 10C - Outlet / Double Switch | 27 |
| GMP 11C - Quad Switch | 27 |
| GMP 12C - Single G.F.I. / Decora | 27 |
| GMP 13C - Double G.F.I. / Decora | 27 |
| GMP 14C - Single G.F.I. / Switch | 27 |
| GMP 15C - Single G.F.I. / Double Switch | 27 |
| GMP 16C - Triple G.F.I. / Decora | 27 |
| GMP 17C - Quad G.F.I. / Decora | 27 |
| GMP 18C - Single G.F.I. / Outlet | 27 |
| GMP 104C - Dimmer Switch | 27 |
| GMP 305C - Double G.F.I. / Switch | 27 |
| Gunther Ultra/Bond Mirror Mastic | 28 |

H

| | |
|---------------------------------|----|
| Heavy Duty Wheel Assembly | 29 |
|---------------------------------|----|

I

| | |
|------------------------|----|
| Invisible Shield | 28 |
|------------------------|----|

L

| | |
|------------------------------|----|
| Lock Assembly - Chrome | 29 |
|------------------------------|----|

M

| | |
|---|----|
| Mirror Tape - 1/8" x 1/2" x 75' | 28 |
| Mirror Tape - 1/16" x 1/2" x 108' | 28 |
| Mirror Tape - 1/32" x 1/2" x 216' | 28 |

P

| | |
|---------------------------|----|
| Purex Glass Cleaner | 28 |
|---------------------------|----|

S

| | |
|--|----|
| Shoe | 29 |
| SIKASIL GP - General Purpose Acetoxy Cure Silicone | 28 |
| SIKASIL SG-10 - Fast Cure Neutral Cure Silicone Assembly Sealant | 28 |
| Single Channel - 9/16" | 29 |
| Single Channel - 13/16" | 29 |

T

| | |
|----------------------------|----|
| Top Guide | 29 |
| Tri-Vue Mirror Frame | 29 |















W

| | |
|----------------------|----|
| Wardrobe Door | 29 |
| Wheel Assembly | 29 |



ANDSCOT METALS

| PROFILE | PART | SIZE/ QTY | SILVER | MATTE BLACK | BRUSHED NICKEL | OIL RUBBED BRONZE |
|---|--|--------------|--------|----------------|-------------------|----------------------|
|  | ACI-15 – Deep “J” Molding | 12’ | 27.78 | 39.46 | 32.04 | 33.63 |
|  | ACI-21 – Shallow “J” Molding | 12’ | 27.78 | 39.46 | 32.04 | |
|  | ACI-26 – L-Bar | 12’ | 21.87 | | | |
|  | ACI-51 – Little Lip | 12’ | 19.16 | | | |
|  | ACI-29 – Face Strip | 12’ | 8.66 | | | |
|  | ACI-30 – End Cap <i>Subject to availability</i> | 12’ | 14.07 | | | |



CLEAR MIRROR COVER PLATES

| IMAGE | PART | SIZE/ QTY | PRICE |
|---|---|--------------|-------|
|  | GMP 2C – Single Outlet | each | 15.76 |
|  | GMP 3C – Single Switch | each | 11.37 |
|  | GMP 6C – Double Outlet | each | 21.30 |
|  | GMP 7C – Outlet / Switch | each | 17.42 |
|  | GMP 8C – Double Switch | each | 13.31 |
|  | GMP 9C – Triple Switch | each | 19.46 |
|  | GMP 10C – Outlet / Double Switch | each | 21.76 |
|  | GMP 11C – Quad Switch | each | 24.78 |
|  | GMP 12C – Single G.F.I. / Decora | each | 17.91 |
|  | GMP 13C – Double G.F.I. / Decora | each | 23.34 |
|  | GMP 14C – Single G.F.I. / Switch | each | 21.87 |
|  | GMP 15C – Single G.F.I. / Double Switch | each | 31.52 |
|  | GMP 16C – Triple G.F.I. / Decora | each | 32.36 |
|  | GMP 17C – Quad G.F.I. / Decora | each | 54.52 |
|  | GMP 18C – Single G.F.I. / Outlet | each | 23.34 |







CLEAR MIRROR COVER PLATES

| IMAGE | PART | SIZE/ QTY | PRICE |
|---|-----------------------------------|--------------|-------|
|  | GMP 104C – Dimmer Switch | each | 28.36 |
|  | GMP 305C – Double G.F.I. / Switch | each | 33.37 |







SILICONE PRODUCTS

| IMAGE | PART | SIZE/ QTY | PRICE EA |
|---|--|--------------|----------|
|  | SIKASIL GP – General Purpose Acetoxy Cure Silicone 432063 – Clear | tube | 7.75 |
| | | case (24) | 166.67 |
|  | SIKASIL-N PLUS US – Neutral Cure Silicone 432053 – Clear | tube | 6.85 |
| | | case (24) | 146.67 |
|  | Dow Corning 786 Silicone Translucent White | tube | 13.39 |
| | | case (12) | 143.52 |















SUNDRIES

| IMAGE | PART | SIZE/ QTY | PRICE |
|---|---|--------------|--------|
|  | Gunther Ultra/Bond Mirror Mastic 300ml tube | each | 8.00 |
|  | Mirror Tape – 1/32" x 1/2" x 216' | roll | 12.00 |
|  | Mirror Tape – 1/16" x 1/2" x 108' | roll | 8.99 |
|  | Mirror Tape – 1/8" x 1/2" x 75' | roll | 10.60 |
|  | Bruce's Glass Stain Remover 10 oz. container | each | 7.28 |
| | | case (6) | 39.00 |
|  | Invisible Shield 16 oz. bottle | each | 10.81 |
| | | case (12) | 115.84 |

SUNDRIES

| IMAGE | PART | SIZE/ QTY | PRICE |
|---|--|--------------|--------|
|  | Butyl Glazing Tape 1/16" x 1/2" x 45" | roll | 3.12 |
| | | case (28) | 83.57 |
|  | Butyl Glazing Tape 1/8" x 1/2" x 30" | roll | 3.22 |
| | | case (28) | 86.24 |
|  | Hang-It™ | each | 10.28 |
|  | Purex Glass Cleaner 5 gallon box | each | 59.90 |
|  | Purex Glass Cleaner 32 oz. bottle | each | 14.27 |
| | | case (12) | 152.99 |
|  | ClearShield AfterCare 500ml bottle | each | 13.96 |

STYLMARK

| PROFILE | PART | SIZE/ QTY | PRICE |
|---|--|-----------------------|---------------|
|  | Single Channel – 9/16" - 110022 <i>Silver</i> <i>Brushed Nickel</i> | 12' | 25.37 |
|  | Single Channel – 13/16" - 110023 <i>Silver</i> <i>Brushed Nickel</i> | 12' | 32.00 |
|  | Double Channel – 9/16" - 110007 <i>Satin Silver</i> <i>Satin Bronze</i> <i>Satin Gold</i> | 12' | 31.73 |
|  | Double Track - 110019 <i>Satin Silver</i> <i>Satin Bronze</i> <i>Satin Gold</i> | 12' | 24.04 |
|  | Shoe - 110012 <i>Satin Silver</i> <i>Satin Bronze</i> <i>Satin Gold</i> | 12' | 34.36 |
|  | Deep Shoe - 110067 <i>Satin Silver</i> <i>Satin Bronze</i> <i>Satin Gold</i> | 12' | 38.22 |
|  | Wheel Assembly - 510001 | each | 1.16 |
|  | Heavy Duty Wheel Assembly - 510041 | each | 1.33 |
|  | Top Guide - 419007 | each | 0.19 |
|  | Glazing Vinyl – 1/4" - 119004 <i>Black</i> | per foot 250' roll | 0.30 74.93 |
|  | Door Pull Assembly – Standard - 510016 <i>Satin Silver</i> <i>Black</i> | each | 12.46 |
|  | Lock Assembly – Chrome - 510040 <i>Brite Silver</i> | each | 38.28 |
|  | Wardrobe Door - 630017 Standard & Custom Sizes | each | Quote |
|  | Tri-Vue Mirror Frame - 620033 Standard & Custom Sizes | each | Quote |

HANG-IT™

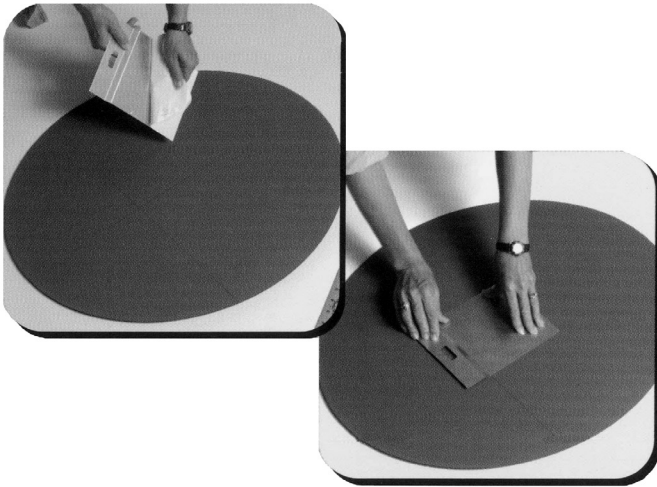

Hang-It™ has been designed to be used with all types of mirrors. It's high strength adhesive backing adheres to all mirror paint backings that meet industry standards. Hang-It™ saves time and labor when installing decorator mirrors. Simply peel off the protective paper on the back of the metal hanger, align the saw tooth slot of the metal hanger with centering lines you have established on the mirror, and press in place. Hang your new mirror on the wall making sure the saw tooth slot is positioned where you want the mirror to be hung.

INSTALLATION INSTRUCTIONS

1. Clean any contaminants from the back of the mirror, using a mixture of alcohol and water or denatured alcohol.
2. Locate the center of the mirror and draw a vertical line from the top to the bottom.
3. Measure down 3" to 6" from the top of the mirror and make a mark on the centering line. This marks the location from the top of the hanger.
4. Locate the center of the hanger. Mark with a line. (The saw tooth slot is centered at the top of the hanger.)
5. Peel the adhesive protective paper from the back of the hanger. Align the centering marks on the mirror and hanger. Press in place, making sure the Hang-It™ bracket is making full contact with the back of the mirror.

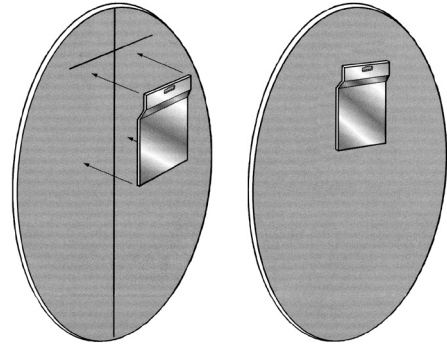

PRECAUTIONS

1. Make sure mirror and Hang-It™ are applied at or above 60° room temperature when assembled.
2. After installing Hang-It™ on the mirror, wait at least 2 hours before hanging the mirror. The adhesive gains strength in time and fully cures in 7 days.
3. Hang-It™ will support decorator mirrors weighting up to 40 lbs.
4. Always use gloves when handling mirrors, to protect yourself and avoid damaging the mirror.

ROBAX® GLASS

ROBAX® glass-ceramic has a thermal endurance far exceeding that of normal tempered glass. Tempered glass is generally limited to applications that do not exceed 500° F. However, ROBAX® is designed to operate at temperatures ranging from minus 400° F to plus 1400° F. Because of its special composition and processing, this unique material can withstand a quench into ice water from red hot temperatures.

With ROBAX® glass-ceramic windows in your stove or fireplace, you can enjoy the fire view with the assurance that the window has been designed with a superior margin of safety for your home and your family.

- This material is actually a transparent glass-ceramic manufactured by Schott Glaswerkes.
- Unlike tempered glass, 1400° glass-ceramic is unstressed.
- Easily cut and sanded – even drilled.
- Will not shatter (like tempered glass).
- Fire to ice without breaking.
- Good strength.

This is an excellent replacement in most applications for any of the following glasses: PYREX®, BOROFLOAT®, TEMPAX®, VYCOR®, PYROCERAM®, AND NEOCERAM®.

Typical applications include: wood stove, pellet stove and coal stove windows; wood and gas fireplace doors; oven door windows; high intensity light covers; furnace observation windows; barbecue grill windows; spark and flame guard panels.



In the photo above, a cutting torch was placed below the ROBAX® and heated until it was red-hot. Cold water was then poured onto the glass from above. There was NO Breakage.

ENDUROSHIELD

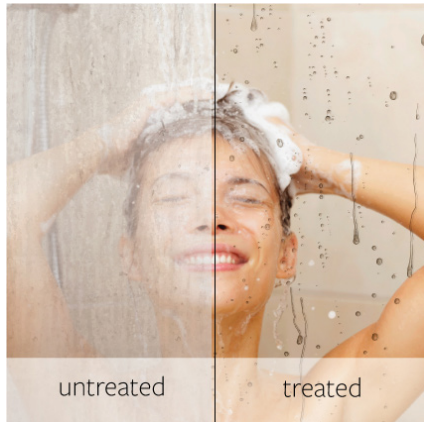



untreated

treated

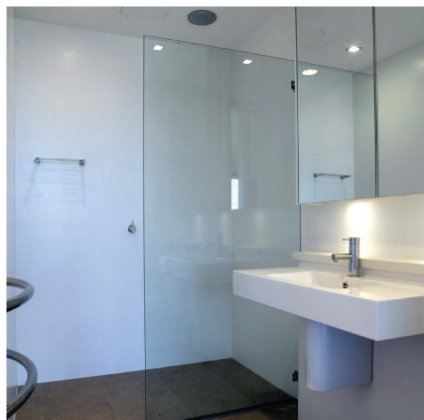

WARRANTY



Save time and money with EnduroShield®, the revolutionary, non-stick treatment that is ideal for shower glass. EnduroShield glass treatment makes cleaning shower glass easy and repels soap scum, grime and dirt. EnduroShield reduces your cleaning time by up to 90%.

Untreated glass is porous and as a result absorbs mineral deposits and soap scum, making it more and more difficult to clean overtime. Shower glass is subject to mineral deposits from water, shampoo, soaps, body fats, and harsh scrubbing using toxic cleaners, causing the glass to discolor and develop irremovable staining. EnduroShield is an ultra-thin transparent glass coating that completely adheres to the surface and provides protection that will repel both water and oil based stains. Similar to a non-stick fry pan, cleaning is made easier using a mild detergent or white vinegar with a damp microfiber cloth. No longer is scrubbing with harsh toxic cleaners needed.

WARRANTY

Extensive testing has proven EnduroShield to last beyond 10 years, enabling a genuine 10-year limited warranty* on all new glass surfaces.

CARE & MAINTENANCE

For best results simply drying the glass with a squeegee or towel after each use will help keep the glass clean and reduce mineral spots forming. The glass needs to be cleaned every few weeks using a damp microfiber cloth and a mild detergent to break down soaps, oils, and conditioners on the glass.

The below products have been tested for compatibility with EnduroShield.

- Lysol 4 in 1 Bathroom Cleaner
- Fantastik Orange Action
- Green Works Natural Glass & Surface Cleaner (by Clorox)
- Mr. Clean Magic Eraser (when damp)

A thorough rinse with clean water should follow immediately after use of any cleaner.

CAUTION: Prohibited Products

Be careful not to use any rough, gritty, abrasive, highly acidic or alkaline cleaners as they may damage the protective coating. This includes products such as Comet (powder), Ajax, or cerium oxide which damage or polish back the actual substrate.

For warranty registration, additional information, and full care instructions visit www.enduroshield.com.

Wisconsin Shower Door

Proud of our past; focused on our future.

Wisconsin Shower Door
N85 W13780 Leon Road
Menomonee Falls, WI 53051

P: 262.251.0088
F: 262.251.0718

Toll Free P: 866.318.0088
Toll Free F: 800.232.1471

Wisconsin Shower Door
I.G. Unit Fabrication
5803 Packer Drive
Wausau, WI 54401

P: 888.329.5194
F: 888.329.5196

