



FLAT GLASS PRICE BOOK

Stock Sheet, Cut to Size, Fabrication, Tempering, I.G. Units & Sundries

WHOLESALE PRICING

Effective 05/2022

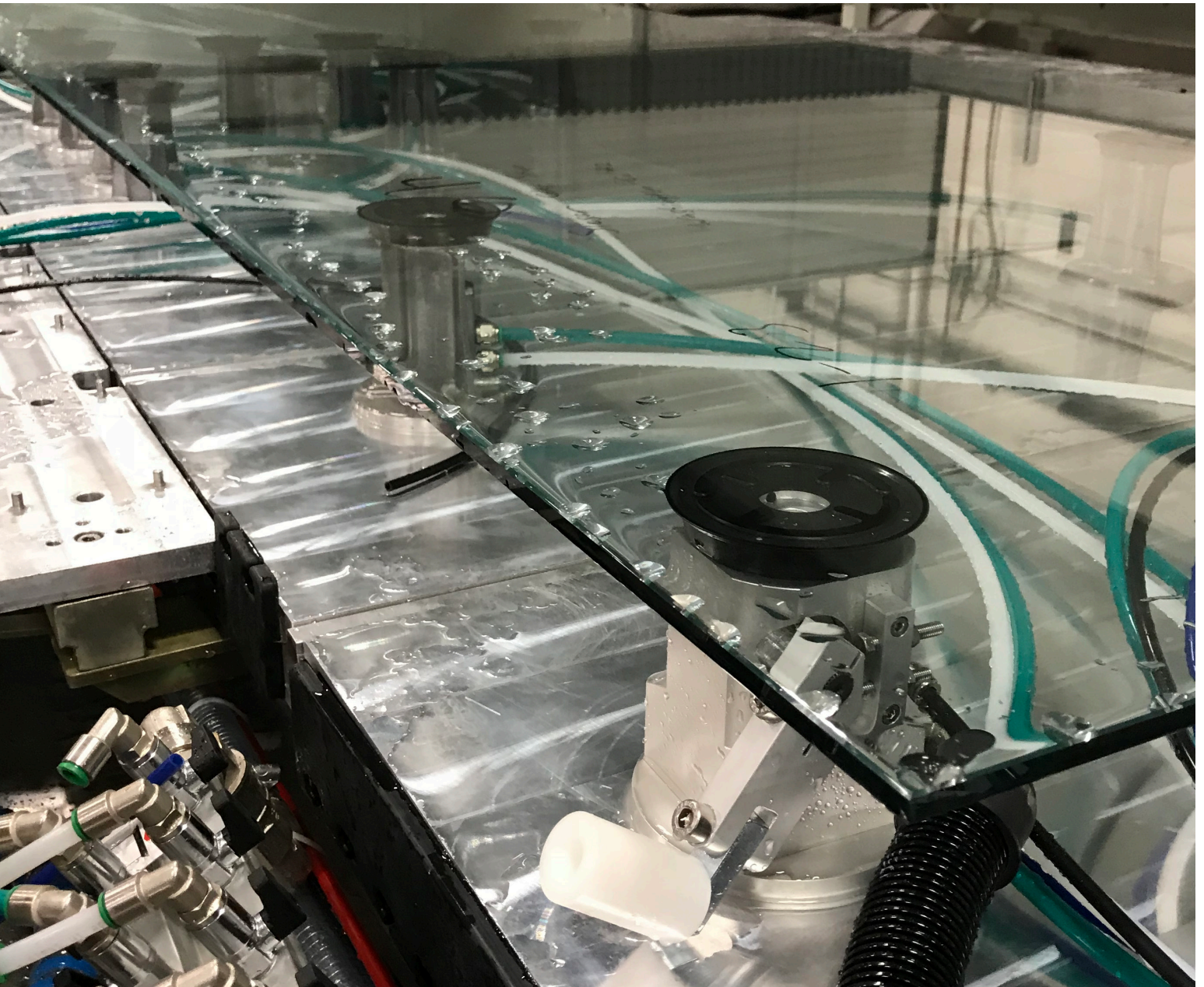

Table of CONTENTS

● STOCK SHEETS

- 4 FLAT GLASS
- 5 MIRROR
- 5 PATTERN GLASS

● FABRICATION

- 6 CUT TO SIZE
- 8 EDGE TREATMENTS
- 9 CORNERS, HOLES & NOTCHES
- 10 PATTERNS
- 11 TEMPERING LIMITATIONS
- 12 PROFILE & SHAPE ILLUSTRATIONS

● TEMPERED GLASS

- 15 DOOR BLANKS
- 16 HG VALUE PACKAGES

● FRAMELESS MIRRORS

- 19 STANDARD SIZE MIRRORS
- 20 DOOR MIRRORS
- 20 FRAMELESS SHAPES

● INSULATED GLASS

- 21 INSULATED GLASS UNITS
- 22 MUNTIN OPTIONS
- 23 INSULATED GLASS DOOR UNITS
- 23 FOAMTITE INTERIOR STORM WINDOWS
- 24 INSULATED GLASS WARRANTY
- 24 INSULATED GLASS PERFORMANCE CHART

● PARTS & SUNDRIES

- 25 INDEX – PARTS
- 26 ANDSCOT METALS
- 27 MIRROR COVER PLATES
- 28 SILICONE
- 28 SUNDRIES
- 29 STYLMARK

○ REFERENCE

- 30 HANG IT™ INSTRUCTIONS
- 31 ROBAX® GLASS
- 32 ENDUROSHIELD

QUOTE REQUESTS - SEND ALL QUOTE REQUESTS TO:

- quotes@wisconsinshowerdoor.com
- Fax to: 262.251.0718

ORDER REQUESTS - SEND TO ORDER REQUESTS TO:

- orders@wisconsinshowerdoor.com
- Fax to: 262.251.0718
- Incomplete orders will be delayed until all information is received; order dates are established once all information is received.

Quotes and Orders will not be processed if sent directly to CSR emails.

STOCK SHEET – FLAT GLASS

		PRICE PER SQUARE FOOT					
		VOLUME PRICING <small>(cannot mix DS & SS with 3/16" or thicker for quantity discounts)</small>					
GLASS		SHEET SIZE		ONE	FIVE	TEN	TWENTY+
SS	Non-Glare	36"	48"	6.65	6.29	*CASE OF 4	
SS	Non-Glare	40"	60"	12.89	11.92	*CASE OF 2	
SS	Clear Plate (3 Sheet Minimum)	48	84	0.72	0.68	0.64	0.63
DS	Clear Plate (2 Sheet Minimum)	48 72	84 84	0.95	0.90	0.85	0.83
3/16"	Clear Plate	72	130	2.04	1.94	1.84	1.81
1/4"	Clear Plate	48	105	2.07	1.97	1.87	1.83
		48	130				
		60	130				
		72	130				
3/8"	Clear Plate	96	130 #	4.62	4.36	4.12	4.03
1/2"	Clear Plate	96	130 #	5.52	5.22	4.96	4.86
1/4"	Optiwhite	96	130 #	4.75	4.55	4.36	4.29
3/8"	Optiwhite	96	130 #	10.36	9.92	9.52	9.37
1/2"	Optiwhite	96	130 #	11.35	10.94	10.56	10.41
3/4"	Optiwhite (Call for Availability)	72	130 #	27.40	26.41	25.49	25.14
3/16	Robax®	43	77	26.77			
1/8"	Bronze/Grey Plate	B: 65 G: 72	96 84	4.39	4.06	3.79	3.68
3/16"	Bronze/Grey Plate	65	96	4.19	3.93	3.70	3.61
1/4"	Bronze/Grey Plate	96	130 #	3.96	3.73	3.54	3.46
3/8"	Bronze/Grey Plate	96	130 #	12.29	11.71	11.18	10.98
1/8"	Midnight Grey	72	84	4.74	4.44	4.18	4.09
1/4"	.030 Clear Laminated	36	84	5.18	5.00	4.83	4.76
		40	80				
		48	84				
		60	96				
1/4"	.030 Bronze Laminated	40	80	6.18	5.96	5.75	5.67
1/4"	.030 Grey Laminated	40	80	6.18	5.96	5.75	5.67
1/4"	.030 Green Laminated	36	84	6.18	5.96	5.75	5.67
		48	84				
1/4"	.030 Hue White Laminated	60	96	7.68	7.40	7.15	7.05

Split Sheet Pricing – Price for one (1) cut to split sheet from stock sheet size as follows: # Split sheets require one (1) production day and will not be available for next day delivery.

- SS – 1/4" – \$7.50 one cut
- 3/8" – \$15.00 one cut
- 1/2" – \$15.00 one cut
- 3/4" – \$50.00 one cut (all 3/4" stock must be split)
- Lami – \$15.00 one cut
- Robax – \$10.00 one cut

#Jumbo sheet stock – Split charges apply // WSD will not deliver jumbo stock sheets

STOCK SHEET – MIRROR

		PRICE PER SQUARE FOOT					
		VOLUME PRICING <small>(cannot mix DS & SS with 3/16" or thicker for quantity discounts)</small>					
MIRROR	SHEET SIZE	ONE	FIVE	TEN	TWENTY+		
DS Clear Mirror (2 Sheet Minimum)	48 84	2.42	2.24	2.15	2.10		
3/16" Clear Mirror	72 120	3.36	3.06	2.91	2.82		
1/4" Clear Mirror	42 120	3.50	3.17	3.01	2.92		
	48 100						
	48 120						
	60 120						
	72 100						
	72 144 #						
1/4" Grey Mirror	72 130	7.32	6.65	6.34	6.15		
1/4" Antique Mirror-Clear	72 130	9.84	9.01	8.62	8.37		
1/4" Clear Laminated Mirror	48 84	14.09	12.56	11.86	11.43		

STOCK SHEET – PATTERN GLASS

PRICE PER SQUARE FOOT							
GLASS	SHEET SIZE		PRICE	GLASS	SHEET SIZE		PRICE
	W	H			W	H	
1/8" German New Antique	56	83	13.74	1/4" Master Carre	78	126	10.47
1/8" Pattern #62	72	84	2.80	1/4" Pattern #62	72	84	3.91
1/8" Velour on Soda Lime	65	96	7.13	1/4" Rain	72	84	4.67
				1/4" Reeded	72	84	7.30
5/32" Cottswald	52	84	7.65	1/4" Velour on Soda Lime	96	130 #	5.86
5/32" Flemish	72	84	7.42				
5/32" Narrow Reeded	65	126 #	6.35	3/8" Glue Chip – Rolled	72	84	10.96
5/32" Renaissance	65	85	7.45	3/8" German New Antique	55	95	43.71
				3/8" Master Carre	80	99	16.90
3/16" Aquatex	72	84	3.03	3/8" Rain	72	96	8.96
				3/8" Reeded	72	84	10.66
1/4" Aquatex	72	84	3.95	3/8" Rolled Cast Glass	72	96	16.45
1/4" Autumn	72	84	9.87	3/8" Velour on Soda Lime	96	130 #	8.96
1/4" Flemish	72	84	8.35	3/8" Velour on Starphire	96	130 #	16.59
1/4" Glue Chip – Rolled	72	84	5.78				
				1/2" Velour on Soda Lime	96	130 #	12.81

CUT-TO-SIZE

**WSD WILL NOT TEMPER
CUSTOMER'S FABRICATED GLASS**

PRICE PER SQUARE FOOT

FABRICATION

		PRICE	
		ANNEALED	TEMPERED

PLATE GLASS

SS	Non-Glare (36" x 48" max)	7.90	
SS	Non-Glare (40" x 60" max)	15.62	

SS	Clear Plate	1.84	
DS	Clear Plate	2.07	3.54
3/16"	Clear Plate	3.12	3.92
1/4"	Clear Plate	3.14	4.16
3/8"	Clear Plate	5.98	6.77
1/2"	Clear Plate	7.02	9.72

1/4"	Optiwhite	6.22	7.35
3/8"	Optiwhite	12.68	14.85
1/2"	Optiwhite	16.05	22.69
3/4"	Optiwhite	40.18	

3/16"	Robax®	45.19	
-------	--------	-------	--

TINTED GLASS

1/8"	Bronze/Grey Plate	5.17	5.30
3/16"	Bronze/Grey Plate	5.67	5.80
1/4"	Bronze/Grey Plate	5.83	6.04
3/8"	Bronze/Grey Plate	16.20	19.54
1/8"	Midnight Grey	5.72	11.74

LAMINATED

1/4"	.030 Clear Laminated	8.54	
1/4"	.030 Bronze Laminated	9.52	
1/4"	.030 Grey Laminated	9.52	
1/4"	.030 Green Laminated	9.52	
1/4"	.030 Hue White Laminated	11.50	

MIRROR

1/8"	Clear Mirror	4.13	
3/16"	Clear Mirror	4.68	
1/4"	Clear Mirror	4.77	

1/4"	Grey Mirror	8.41	
------	-------------	------	--

1/4"	Antique Mirror-Clear	12.55	
------	----------------------	-------	--

1/4"	Clear Laminated Mirror	14.57	
------	------------------------	-------	--

		PRICE	
		ANNEALED	TEMPERED

LOW E (ENERGY ADVANTAGE)

1/8"	Low E (Energy Advantage)	5.57	6.59
3/16"	Low E (Energy Advantage)	6.74	7.70

PATTERN GLASS

1/8"	Clear Seedy	CALL	
1/8"	Clear Water	CALL	
1/8"	German New Antique	21.00	
1/8"	Pattern #62	4.98	5.87
1/8"	Velour on Soda Lime	7.33	7.90

5/32"	Cottswald	11.09	
5/32"	Flemish	11.88	
5/32"	Narrow Reeded	9.71	
5/32"	Renaissance	10.79	

3/16"	Aquatex	4.67	5.84
-------	---------	------	------

1/4"	Aquatex	6.97	9.29
1/4"	Autumn	15.22	17.04
1/4"	White (Back-Painted) on Low-Iron	16.40	18.22
1/4"	Flemish	13.52	15.96
1/4"	Glue Chip – Rolled	10.81	13.43
1/4"	Master Carre	15.11	17.84
1/4"	Misco Wire	16.83	
1/4"	Pattern #62	6.95	8.83
1/4"	Rain	6.34	9.28
1/4"	Reeded	13.86	16.29
1/4"	Velour on Soda Lime	8.03	11.05

3/8"	Glue Chip – Rolled	19.38	22.15
3/8"	German New Antique	57.56	60.71
3/8"	Master Carre	27.43	30.09
3/8"	Rain	12.58	15.71
3/8"	Reeded	17.43	18.59
3/8"	Rolled Cast Glass	26.40	29.39
3/8"	Velour on Soda Lime	15.22	18.22
3/8"	Velour on Starphire	29.03	31.49

1/2"	Velour on Soda Lime	24.25	29.36
------	---------------------	-------	-------

CUT-TO-SIZE SPECIFICATIONS

FABRICATION

SPECIFICATIONS & ADDITIONAL CHARGES								
		GLASS THICKNESS						
		DS & SS	5/32	3/16"	1/4"	3/8"	1/2"	3/4"
Minimum Quantities								
Annealed - Translucent & Mirror per order	1 sq ft - All glass thicknesses							
Annealed - Pattern Glass	1 sq ft per piece						3 sq ft per order	
Annealed - Robax	No Min.							
Tempered - All Glass Types per piece	3 sq ft - All glass thicknesses							
Dimensions & Tolerances								
Out of Square	WSD does not charge for out of square conditions							
Tolerances	±1/16"	±1/16"	±1/16"	±1/16"	±1/8"	±1/8"	±3/16"	
Hold Exact Size	Add 20% to order							
Edgework Requirements								
Annealed	All annealed shipped goods will be seamed // Seaming charges apply (see page 8)							
Tempered	All tempered includes seaming in tempering price					Satin Polish (charges apply)		
Size Charges								
Undersize Items	Lites with a width of less than 10" will be calculated as a minimum of 10" All glass thicknesses							
Undersize Charge Charged on items less than 8" down to 2" that require bevel or miter						\$95.00	\$95.00	\$95.00
Tempered Oversize Charge Charged on glass ≥ 120"	Add 75% to square foot price							
Oversize Charge (per piece)	\$24.95 multiplied by Oversize Quantity							
Oversize Quantity = sq ft of piece / thickness figure <i>Note: Oversize Quantity must be 1 or greater for oversize charge to apply</i>	Oversize Quantity Example (using 1/4" glass) $\frac{\text{sq ft of piece}}{\text{thickness figure}} = \frac{36 \text{ sq ft}}{24 \text{ sq ft}} = 1.5$	Thickness Figure (below)						
		24 sq ft	24 sq ft	20 sq ft	15 sq ft	7 sq ft		
Other Charges								
EnduroShield	Add \$3.15 per sq ft (Care Package not included)							
Tempering Limitations - Additional tempering limitations can be found on page 11								

EDGE TREATMENTS

STRAIGHT LINE EDGE TREATMENT					PRICE PER INCH		
ALWAYS USE NEXT EVEN INCH x PRICE OF EDGE WORK							
GLASS THICKNESS							
TREATMENT	1/8"	3/16"	1/4"	1/4" LAMI	3/8"	1/2"	3/4"
Seamed Edge	0.048	0.048	0.048	0.048	0.107	0.143	0.202
Flat Polish Edge	0.083	0.083	0.083	1.000 ¹	0.178	0.239	0.357
½" Bevel	0.166	0.119	0.119		0.303	0.357	0.571
¾" Bevel		0.154	0.154		0.341	0.393	0.619
1" Bevel		0.197	0.197		0.384	0.441	0.702
1 ¼" Bevel		0.239	0.239		0.429	0.476	0.810
1 ½" Bevel		0.322 NT	0.322 NT		0.516	0.559	0.976
2" Bevel NT			1.071 NT		1.304 NT	1.310 NT	2.429 NT
Double Bevel NT			Quote		Quote	Quote	Quote
Dual Bevel NT					Quote	Quote	Quote
0-45° Miter			0.715		0.834	1.012	1.322
Chamfer					0.834	1.012	1.322
Pencil Polish	Pencil Polish Minimum \$25.00		0.453	1.000	0.512	0.583	1.012

SHAPE / DIAMETER EDGE TREATMENT					PRICE PER INCH		
ALWAYS USE NEXT EVEN INCH x PRICE OF EDGE WORK							
GLASS THICKNESS							
TREATMENT	1/8"	3/16"	1/4"	1/4" LAMI	3/8"	1/2"	3/4"
Seamed Edge	0.048	0.059	0.059	0.059	0.107	0.143	0.202
Flat Polish Edge		0.453	0.453	1.000 ¹	0.512	0.583	1.012
½" Bevel	0.846	0.846	0.846		0.976	1.048	1.863
¾" Bevel		0.917	0.917		1.059	1.131	2.000
1" Bevel		1.000	1.000		1.131	1.203	2.168
1 ¼" Bevel		1.059	1.059		1.263	1.334	2.393
1 ½" Bevel			1.548 NT		1.691	1.751	3.227
Double Bevel NT					Quote	Quote	Quote
Dual Bevel NT					Quote	Quote	Quote
Pencil Polish			0.453	1.000	0.512	0.583	1.012

ADDITIONAL CHARGES	MINIMUM CHARGES
Polish 5 to 8 straight-sided pieces – Requires shapes polish	Straight Line Edge Work on Bevel Only – \$15.28 per order
Bevel 5 to 8 straight-sided pieces – Add 35% to order (Use straight line bevel charge)	Shape Edge Treatment – \$28.35 per piece
Special degree bevel – \$29.48 Setup plus per inch bevel	2" Bevel – \$28.35 Setup Charge plus \$52.00 Edge Work minimum
Add 35% to Edge Treatment for customer supplied glass	

NT - Not able to be tempered

¹ - Laminated requires minimum width of 4" in order to polish

See page 12 for profiles of edge treatments.

CORNERS, NOTCHES, HOLES

		PRICE PER EACH					
		GLASS THICKNESS					
CORNERS (per corner unless otherwise stated)	1/8"	3/16"	1/4"	1/4" LAMI	3/8"	1/2"	3/4"
Flat Polish Radius Corner up to 10" (Max 4 corners per piece)	Setup	10.21	10.21		18.15	24.95	36.29
Add one (1) Setup Charge for up to (4) corners plus Shape Edge Treatment (per inch) for entire perimeter	Shape Edge	0.453	0.453		0.512	0.583	1.012
1" Bevel (Illustration on page13)			18.68		18.68	24.95	49.90
1 1/2" Bevel (Illustration on page13)			18.68 NT		18.68	24.95	49.90
1", 1 1/2" Beveled Radius Corner NT (Illustration on page 13)			49.90 NT		49.90 NT	56.16 NT	81.00 NT
Bump Corners		1.24	1.24	3.08	3.08	6.21	9.07
HOLES - (COUNTERSINK HOLES (up to 1 1/2" diameter countersink) - HOLE PRICING 2X)							
1/8", 3/16", 1/4", 5/16", 3/8", 7/16", 1/2", 9/16", 5/8", 3/4"	4.00	4.00	4.00	Quote	6.80	9.07	31.16
1", 1 1/16", 1 3/16", 1 1/4", 1 1/2", 1 5/8", 1 3/4", 2", 2 1/4", 2 1/2"	6.26	6.26	6.26	Quote	19.82	19.82	39.69
3", 3 1/2", 4"	18.68	18.68	18.68	Quote	37.42	37.42	62.37
4 1/4" and up - CNC (\$40 minimum)							
SWITCHES OR OUTLETS – DRILLED NON-FINISHED INTERIOR EDGE							
Single (Std. Size - 2 1/4" x 4 1/2")		19.60	19.60				
Double (Std. Size - 4 1/4" x 4 1/2")		39.31	39.31				
Triple (Std. Size - 6 1/4" x 4 1/2")		58.97	58.97				
Quad (Std. Size - 8" x 4 1/2")		78.57	78.57				
NOTCHES – MILLED SATIN ARIS EDGE // ALL NOTCHES HAVE 3/8" RADIUS (MINIMUM)							
Edge/Corner – Minimum Charge up to 30 U.I. Replaces Edge Notch (Hinge Notch)		29.48	29.48	Quote	37.15	41.85	61.24
Edge/Corner – >30 U.I. to 100 U.I. (per inch)		1.021	1.021	Quote	1.429	1.610	2.087
Edge/Corner – >100 U.I.		Quote	Quote	Quote	Quote	Quote	Quote
SANDBLASTED PLATE RAIL – \$28.35 Setup Charge per piece + \$1.89 per inch							
V-GROOVE – Please fax drawings for quote							
ETCHED FINGER PULL– \$38.50 - Standard Size 5/8" x 2 3/4"							

FABRICATION

OUT OF SQUARE DRAWING REQUIREMENTS

All dimensions provided are to be centerline dimensions.
Ensure all out-conditions add-up before placing order.

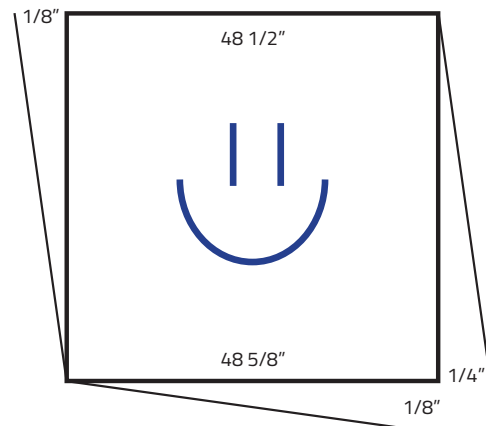
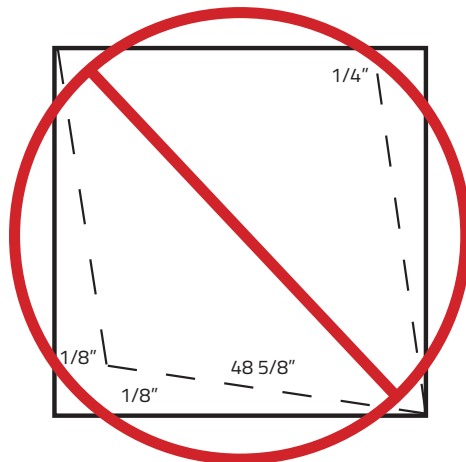

PATTERNS

PATTERN CHARGES –

	PATTERN CHARGE
Diameter Patterns on 3/8" & 1/2"	20.00
Diameter Patterns on 3/4" & Lami	35.00
Patterns for thicknesses on glass $\leq 3/16"$ with a seamed edge	20.00
Patterns on all other glass thicknesses with a seamed edge & Patterns on all glass thicknesses with a polished or beveled edge	45.00
Patterns on laminated glass	60.00

ADDITIONAL CHARGES - 5-8 sided patterns require shapes polishing.

BLOCK SIZE CALCULATIONS – Additional material is required during the fabrication process to create a quality pattern. Use the following table to find your glass thickness and add the listed measurement to each dimension to determine the correct block size needed for your pattern.

THICKNESS	ADD TO EACH DIMENSION
1/8"	2"
3/16"	
1/4"	
3/8"	4"
1/2"	
3/4"	
3/4"	6"

CUTOUTS – Customers are responsible for cutting out patterns. A full size pattern is require for shapes other than squares, rectangles & diameters.

DIAMETERS - Diameters/Patio Tables of 38" or greater on 3/16" & 1/4" pattern glass will be charged for a full stock sheet of pattern glass at cut-to-size pricing.

MATERIAL – Reference the following chart for acceptable pattern materials. WSD will return all patterns submitted on unacceptable materials.

ACCEPTABLE	UNACCEPTABLE
Luan	Tissue Paper
Masonite	Wrapping Paper
White Butcher Paper	Newspaper
Glass	Brown Kraft Paper
Cardboard	Rosin Paper

PATTERN MATCHING - WSD will match the submitted pattern; not dimensions. **Submitted patterns must specify viewing from smooth or textured surface.**

QUALITY – The quality of the pattern that you send to WSD directly impacts the quality of the finished goods.

TEMPERING LIMITATIONS

HOLES AND NOTCHES – This chart should be used to determine minimum sizes and placement of holes and notches in tempered glass:

GLASS THICKNESS (t)	1/8"	3/16"	1/4"	3/8"	1/2"	GENERAL RULE
Minimum Diameter of Holes (A)	1/4"	1/4"	1/4"	3/8"	1/2"	$A \geq t$
Distance from Hole Rim to Edge of glass (B)	1/4"	3/8"	3/8"	9/16"	3/4"	$B \geq 1.5t$
Distance between rims of holes (C)	3/8"	3/8"	1/2"	3/4"	1"	$C \geq 2t$ and $3/8"$
Distance from Corner to Rim of Hole (E)	13/16"	1 7/32"	1 5/8"	2 7/16"	3 1/4"	$E \geq 6.5 \times t$
Minimum Fillet Radius (F)	3/8"	3/8"	3/8"	3/8"	3/8"	

- Countersink holes require technical review and approval before order acceptance.
- Large holes and notches greater than 1/3 the narrow dimension require technical review and approval.

HOLE AND NOTCH LOCATION TOLERANCES

- For dimensions of hole center from specified edge $\pm 1/16"$
- For dimensions between hole centers $\pm 1/16"$
- Chips and flakes will not exceed $1/16"$
- Notch dimensions for glass 1/4" and under $\pm 1/16"$
- Notch dimensions for 3/8" and 1/2" $\pm 1/8"$

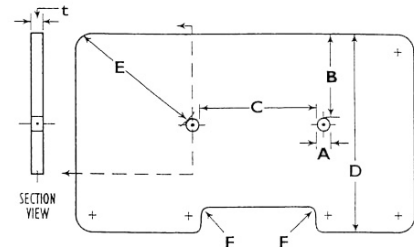

TEMPERED SIZE RANGE – Three (3) square foot minimum, odd or fractional dimensions will be billed at the next higher even inch.

THICKNESS	MINIMUM SIZE	MAXIMUM SIZE	GLASS SIZE TOLERANCE
1/8"	5" x 11"	32" x 74"	$\pm 1/16"$
3/16"		72" x 120"	
1/4"	3" x 11"	84" x 130"	$\pm 1/8"$
3/8" - 1/2"			
Glass over 120" add 75% to appropriate square foot price			Hold to exact size - Add 20% to order

EDGE TREATMENT – Tempered glass has seamed edges unless ordered with polished edges. The seamed edge is not a suitable exposed finished edge. 1/2" tempered glass requires satin polished edge.

TEMPERED CERTIFICATION LOGO – Tempered glass is permanently labeled unless ordered "NO LOGO".

DISTORTION – Heat treating adds distortion to glass products. All requirements for distortion, roller wave, consistent furnace orientation or distortion measurement must be disclosed at quotation and order.

STRAIN PATTERN - Tempered glass contains a strain pattern or "Quench Marks" that appear as areas of shadows in a pattern corresponding to the location of air nozzles in the tempering furnace quench section. This condition becomes more visible:

- Under certain lighting conditions, like polarized sunlight
- When the glass is viewed at glancing angles
- With tinted glass, especially when multiple lites are combined in laminated and insulating constructions

The strain pattern is not considered a defect in tempered glass products.

SPONTANEOUS BREAKAGE – Tempered glass is subject to rare spontaneous breakage, where the glass will break for no apparent reason.

INSTALLATION - Monolithic low light transmitting glass (i.e. Midnight Grey, Low-E, 3/8" and 1/2" Bronze and Grey) should be glazed with a consistent tin side/ air side orientation.

CRATING -WSD no longer offers crating as a delivery option.

FABRICATION – All fabrication that penetrates the glass surface (i.e. holes, notches, sand blasting, cutting) must take place prior to tempering.

GLASS QUALITY - All tempered glass shall conform to Consumer Product Safety Commission (CPSC) Standard 16 CFR 1201.

CERTIFICATE OF TEMPERING - Certificate of tempering are available upon request.

CANCELLATIONS - If manufacturing has started on an order and changes or cancellation occurs, the customer will be shipped the raw glass and billed for the same.

EDGE WORK PROFILES

EDGEWORK INCLUDES HIGH POLISH EXCEPT AS NOTED*

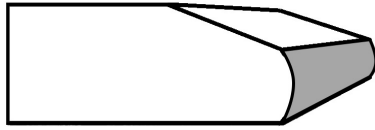

Beveled Edge*

Available on 1/8", 1/4", 3/8", 1/2", 3/4" glass thickness

*Satin Edge

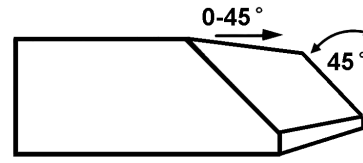

0-45° Miter Edge

Available on 1/4", 3/8", 1/2", 3/4" glass thickness

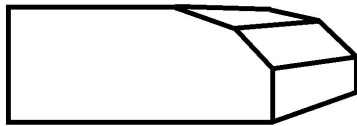

Double Beveled Edge

Available on 1/4", 3/8", 1/2", 3/4" glass thickness

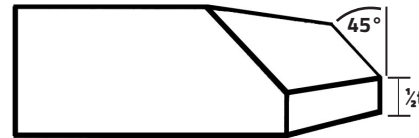

Chamfer Edge

Available on 3/8", 1/2", 3/4" glass thickness

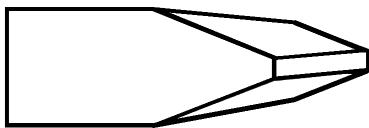

Dual Beveled Edge

Available on 3/8", 1/2", 3/4" glass thickness

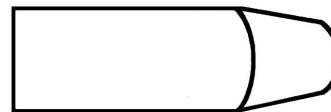

Pencil Polish Edge

Available on 1/4", 3/8", 1/2", 3/4" glass thickness



Flat Polish Edge

Available on 3/16", 1/4", 3/8", 1/2", 3/4" glass thickness

BEVELED STRAIGHT LINE ILLUS.

1" straight line bevel with 1-1/4" radius corner to retain 1" bevel at radius corner.

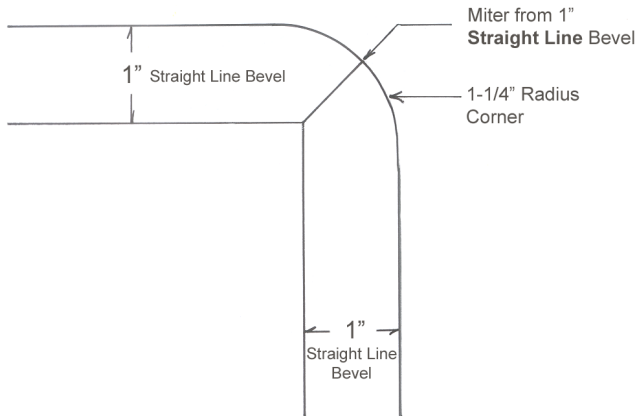

1-1/2" straight line bevel with 1-3/4" radius corner to retain 1-1/2" bevel at radius corner.

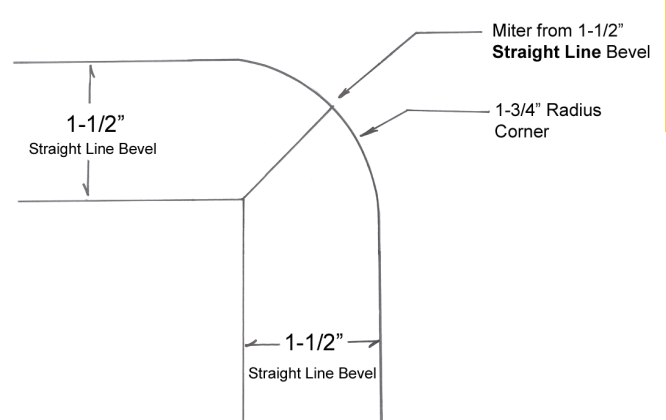

FABRICATION

BEVELED RADIUS CORNER ILLUS.

1" or 1-1/2" beveled radius corner - minimum 2" radius on outside corner.

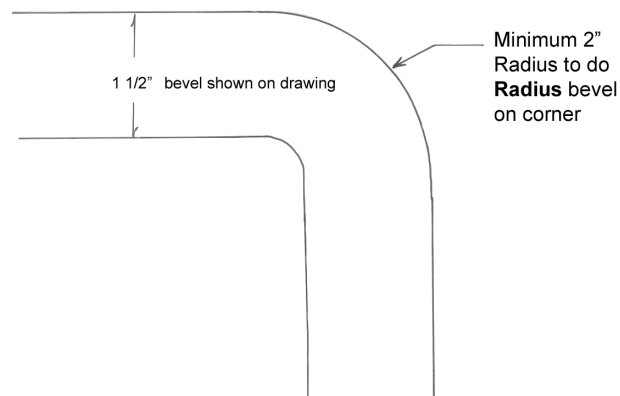

SHAPES

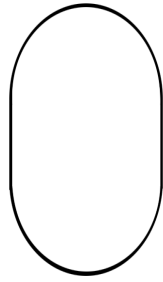

Race Track

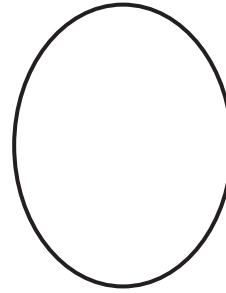

Oval/Elliptical

Requires a pattern



Queen Anne

Requires a pattern

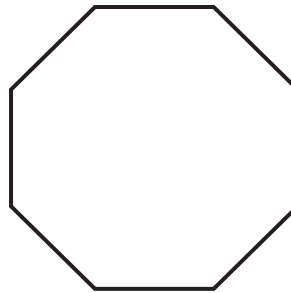

Octagon

Measure flat to flat or requires a pattern

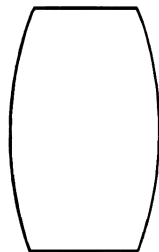

Boat

Requires a pattern

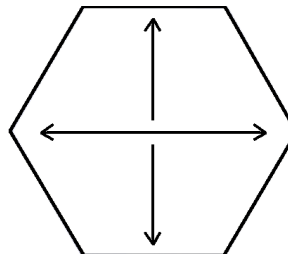

Hexagon

Measure point to point and flat to flat or requires a pattern

FORMULAS FOR CALCULATING INCHES ON SHAPES

Radius Top	Width x 1.6
Ovals (Ellipticals)	(Length + Width) x 1.7
Circle	Diameter x 3.14
Octagon (8 equal sides)	Width x 3.4
Hexagon (6 equal sides)	Width x 3

STOCK TEMPERED - DOOR BLANKS

DOOR BLANK SIZE

	28" x 71 1/2"	28" x 75 1/2"	28" x 79 1/2"
3/8" Clear Glass Door Blank	152.00	154.00	156.00

Door Blank Features: 3/8" clear glass, polished on all edges, 8" CTC 1/2" holes for handles and 2 notches for hinges

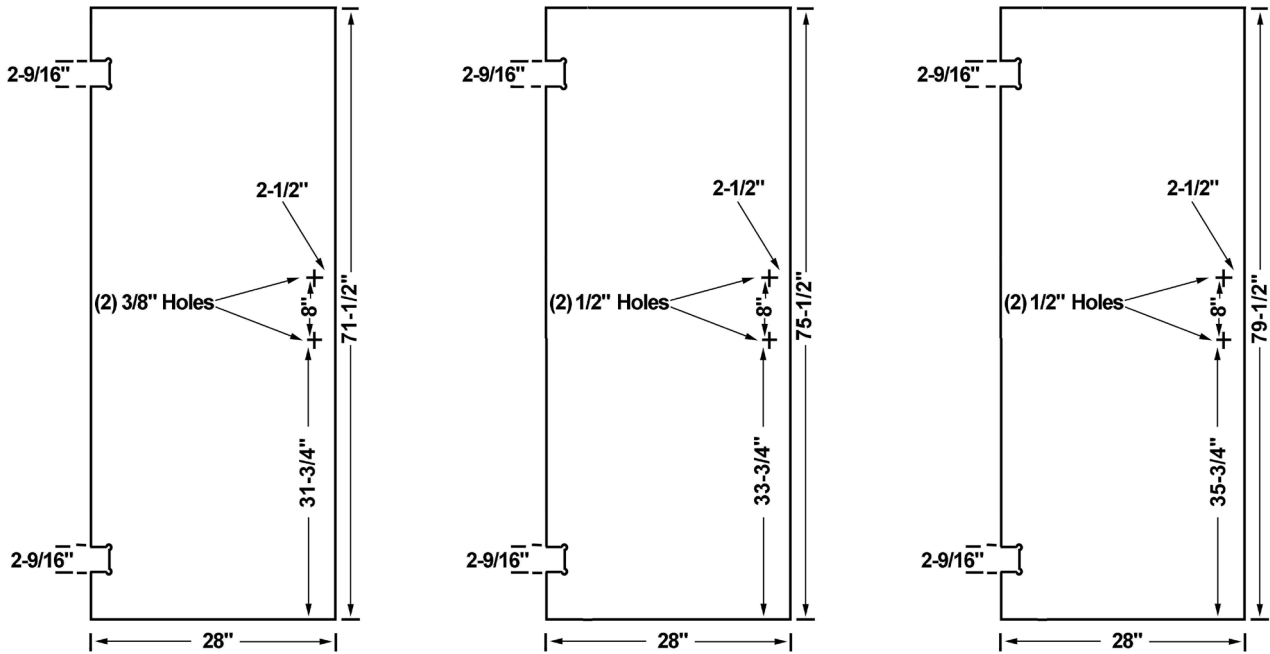

TEMPERED

STANDARD DOOR HEIGHTS FOR HEAVY GLASS STANDARD HINGE DOOR BLANKS

	OVERALL HEIGHT	OVERALL HEIGHT WITH A SC-915 CURB
28" x 71 1/2"		
Stand alone	72"	72 7/16"
SC-646 Header	73 7/8"	74 5/16"
Horizon Header	73 1/2"	73 15/16"
28" x 75 1/2"		
Stand alone	76"	76 7/16"
SC-646 Header	77 7/8"	78 5/16"
Horizon Header	77 1/2"	77 15/16"
28" x 79 1/2"		
Stand alone	80"	80 7/16"
SC-646 Header	81 7/8"	82 5/16"
Horizon Header	81 1/2"	81 15/16"

STANDARD DOOR HEIGHTS FOR HEAVY GLASS PIVOT HINGE DOOR BLANKS

	OVERALL HEIGHT	OVERALL HEIGHT WITH A SC-915 CURB
28" x 71 1/2"		
Stand alone	72"	72 7/16"
SC-646 Header	74"	74 7/16"
Horizon Header	73 1/2"	73 15/16"
28" x 75 1/2"		
Stand alone	76"	76 7/16"
SC-646 Header	78"	78 7/16"
Horizon Header	77 1/2"	77 15/16"
28" x 79 1/2"		
Stand alone	80"	80 7/16"
SC-646 Header	82"	82 7/16"
Horizon Header	81 1/2"	81 15/16"

WALL TO GLASS HINGES

HINGE	FINISH	DOOR BLANK SIZE		
		28" x 71 1/2"	28" x 75 1/2"	28" x 79 1/2"
Premier Package	Chrome	243.00	245.00	247.00
	Brushed Nickel	244.00	246.00	248.00
	Oil Rubbed Bronze (dark)	252.00	254.00	256.00
Symphony Package	Chrome	249.00	251.00	253.00
	Brushed Nickel	249.00	251.00	253.00
	Oil Rubbed Bronze (medium)	265.00	267.00	269.00

Each package will include a door blank (3/8" clear glass, polished on all edges, 8" CTC 1/2" holes for handles and 2 notches for hinges), 2 hinges and an 8" back to back C-Pull. Packages DO NOT include polycarbonate components. PLEASE SPECIFY YOUR CHOICE OF 0° OR 5° PIN ON YOUR ORDER.

TEMPERED

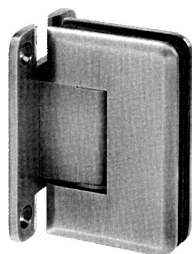

US Horizon Premier Hinge
Wall to Glass hinge with full plate.
Available in 0° or 5° load



Portals Symphony Hinge
Wall to Glass with full plate.
Available in 0° or 5° load.

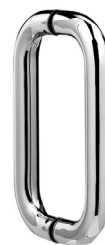

8" Back to Back C-Pull

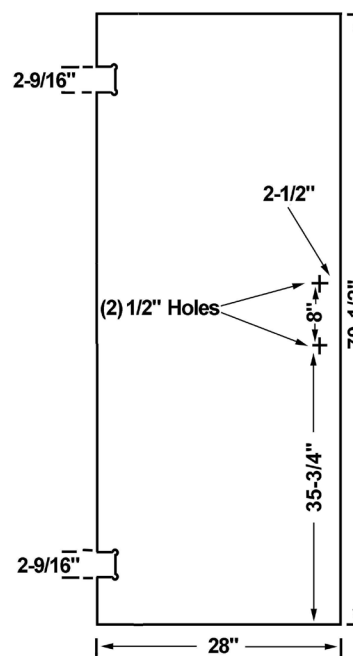
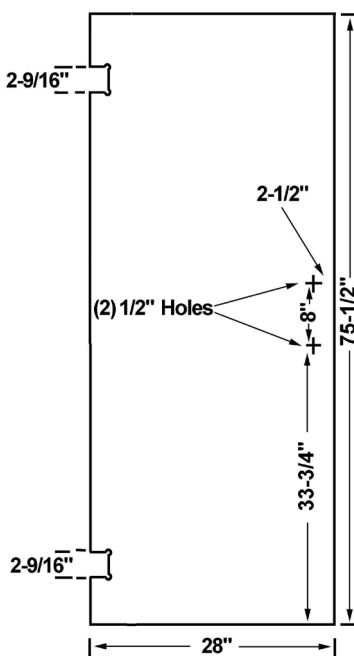
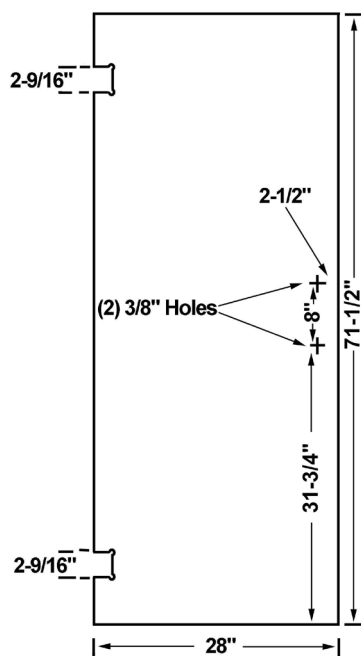

180° GLASS TO GLASS HINGES

HINGE	FINISH	DOOR BLANK SIZE		
		28" x 71 1/2"	28" x 75 1/2"	28" x 79 1/2"
Premier Package™	Chrome	271.00	273.00	275.00
	Brushed Nickel	274.00	276.00	278.00
	Oil Rubbed Bronze (dark)	308.00	310.00	312.00
Symphony Package	Chrome	261.00	263.00	265.00
	Brushed Nickel	269.00	271.00	273.00
	Oil Rubbed Bronze (medium)	277.00	279.00	281.00

Each package will include a door blank (3/8" clear glass, polished on all edges, 8" CTC 1/2" holes for handles and 2 notches for hinges), 2 hinges and an 8" back to back C-Pull. Packages DO NOT include polycarbonate components. PLEASE SPECIFY YOUR CHOICE OF 0° OR 5° PIN ON YOUR ORDER.

TEMPERED



US Horizon Premier Hinge
180° Glass to Glass hinge.
Available in 0° or 5° load



Portals Symphony Hinge
180° Glass to Glass hinge.
Available in 0° or 5° load.

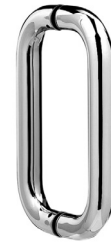

8" Back to Back C-Pull

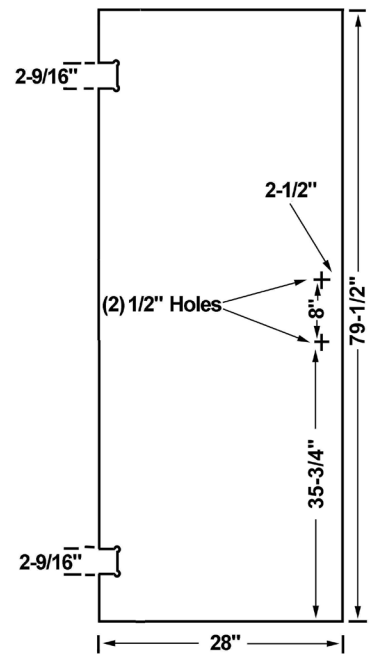
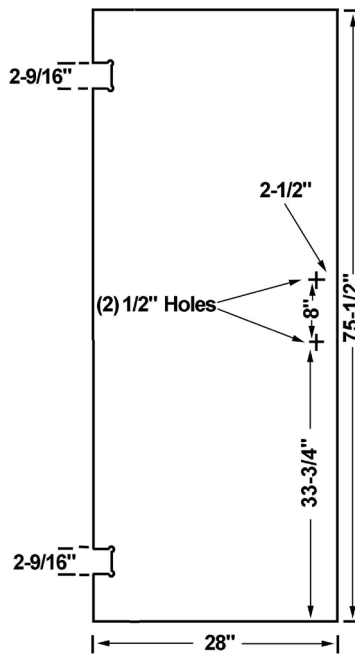
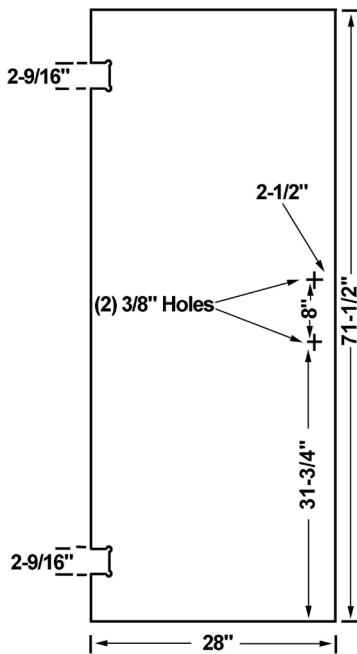

PIVOT HINGES

HINGE	FINISH	DOOR BLANK SIZE		
		28" x 71 1/2"	28" x 75 1/2"	28" 79 1/2"
Montreal Package	Chrome	251.00	253.00	255.00
	Brushed Nickel	252.00	254.00	256.00
	Oil Rubbed Bronze (dark)	278.00	280.00	282.00

Each package will include a door blank (3/8" clear glass, polished on all edges, 8" CTC 1/2" holes for handles and 2 notches for hinges), 2 pivot hinges and an 8" back to back C-Pull. Packages DO NOT include polycarbonate components. PLEASE SPECIFY YOUR CHOICE OF 0° OR 5° PIN ON YOUR ORDER.

TEMPERED



US Horizon Montreal Hinge
Beveled pivot hinge, ceiling or curb mount.

8" Back to Back C-Pull

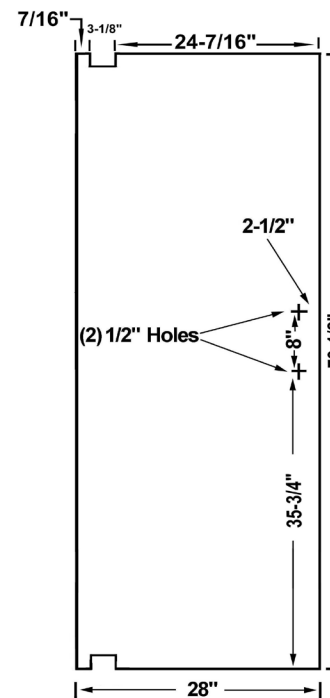
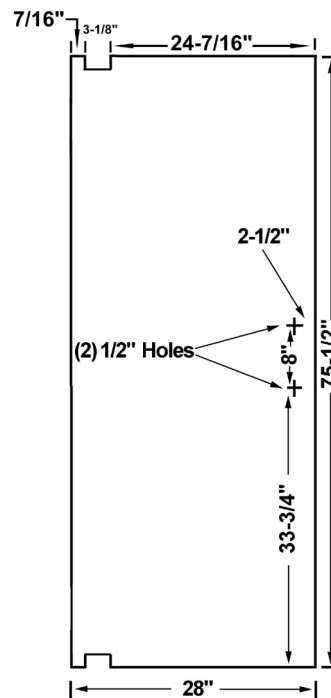
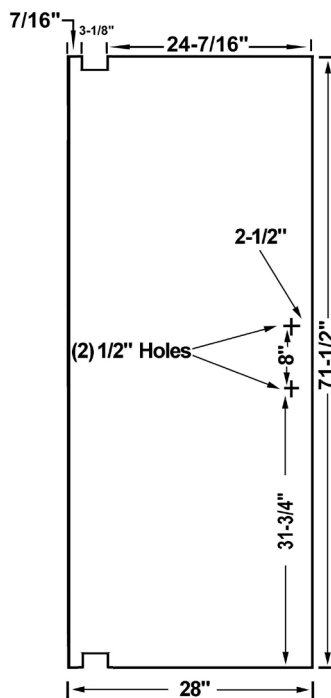

STANDARD SIZE MIRRORS

**NON-STOCK ITEMS
STANDARD FABRICATION &
DELIVERY TIMES APPLY**

STANDARD SIZES	POLISHED			1/2" BEVEL			1" BEVEL		
	VOLUME PRICING			VOLUME PRICING			VOLUME PRICING		
	1-24	25-49	50+	1-24	25-49	50+	1-24	25-49	50+
24" x 30"	24.97	23.92	22.57	27.29	26.15	24.69	32.11	30.79	29.11
24" x 36"	29.44	28.19	26.60	32.00	30.65	28.94	37.31	35.78	33.82
30" x 36"	35.80	34.28	32.35	38.58	36.96	34.90	44.35	42.53	40.20
36" x 36"	42.16	40.37	38.10	45.17	43.27	40.85	51.39	49.28	46.58
42" x 36"	48.52	46.47	43.85	51.75	49.58	46.81	58.43	56.03	52.96
48" x 36"	54.88	52.56	49.60	58.33	55.88	52.76	65.47	62.78	59.35
54" x 36"	61.25	58.65	55.34	64.92	62.19	58.72	72.51	69.53	65.73
60" x 36"	67.61	64.74	61.09	71.50	68.50	64.67	79.55	76.28	72.11
66" x 36"	73.97	70.83	66.84	78.09	74.81	70.63	86.59	83.03	78.49
72" x 36"	80.33	76.93	72.59	84.67	81.11	76.58	93.63	89.78	84.87
24" x 40"	32.41	31.04	29.29	35.13	33.66	31.78	40.78	39.11	36.97
30" x 40"	39.41	37.74	35.61	42.34	40.57	38.30	48.43	46.44	43.90
36" x 40"	46.40	44.43	41.93	49.55	47.47	44.82	56.08	53.78	50.84
42" x 40"	53.40	51.13	48.25	56.77	54.38	51.34	63.74	61.12	57.77
48" x 40"	60.39	57.83	54.57	63.98	61.29	57.87	71.39	68.46	64.71
54" x 40"	67.39	64.53	60.89	71.19	68.20	64.39	79.04	75.79	71.65
60" x 40"	74.38	71.23	67.21	78.40	75.11	70.91	86.69	83.13	78.58
66" x 40"	81.38	77.93	73.53	85.61	82.01	77.43	94.35	90.47	85.52
72" x 40"	88.37	84.63	79.86	92.82	88.92	83.95	102.00	97.81	92.45
24" x 42"	33.90	32.46	30.63	36.70	35.16	33.20	42.51	40.77	38.54
30" x 42"	41.21	39.46	37.24	44.23	42.37	40.00	50.47	48.40	45.75
42" x 42"	55.83	53.47	50.45	59.27	56.78	53.61	66.39	63.66	60.18
48" x 42"	63.15	60.47	57.06	66.80	63.99	60.42	74.35	71.29	67.39
54" x 42"	70.46	67.47	63.67	74.32	71.20	67.22	82.31	78.92	74.61
60" x 42"	77.77	74.47	70.27	81.85	78.41	74.03	90.26	86.56	81.82
66" x 42"	85.08	81.47	76.88	89.37	85.62	80.84	98.22	94.19	89.03
72" x 42"	92.39	88.48	83.49	96.90	92.83	87.64	106.18	101.82	96.25

FRAMELESS

Standard Size Mirrors Tolerance - ±1/4"

Boxing charge for Standard Size Mirrors & Door Mirrors: Up to 42" – \$8.00 // For 48" up to 72" – \$11.00

DOOR MIRRORS

**NON-STOCK ITEMS
STANDARD FABRICATION &
DELIVERY TIMES APPLY**

		FLAT POLISH	1/2" BEVEL
16" x 68"	1/4" Clear Mirror	35.96	39.28
18" x 68"	1/4" Clear Mirror	39.57	42.93
20" x 68"	1/4" Clear Mirror	43.17	46.58
22" x 68"	1/4" Clear Mirror	46.78	50.23
24" x 68"	1/4" Clear Mirror	50.38	53.88

Boxing charge for Standard Size Mirrors & Door Mirrors: Up to 42" – \$8.00 // For 48" up to 72" – \$11.00

FRAMELESS

IMPORTED FRAMELESS SHAPES*

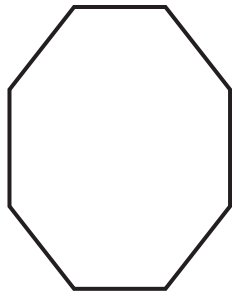

OCTAGON		1" BEVEL
22" x 28"	3/16" Clear Mirror	51.11
24" x 36"	3/16" Clear Mirror	62.06

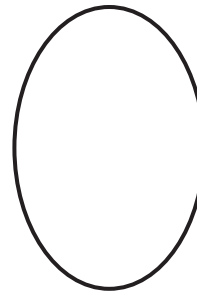

OVAL		1" BEVEL
21" x 31"	3/16" Clear Mirror	57.80
24" x 37"	3/16" Clear Mirror	69.27

Imported Frameless Shapes include backer with individual carton

*Imported Frameless Shapes are sold "as-is". These are not custom mirrors and are not held to normal industry specifications.

I.G. UNIT FABRICATION

PRICE PER SQUARE FOOT						
GLASS		ANNEALED	TEMPERED	LOW – E (Energy Advantage)		LOW-E (7036 ClimaGuard)
				ANNEALED	TEMPERED	ANNEALED
SS	Clear	5.79				8.68
DS	Clear	5.79	8.44	8.43	11.48	8.68
3/16"	Clear	6.72	8.78	9.86	11.83	10.42
1/4"	Clear	7.09	8.80			
DS	Bronze/Grey	7.88	11.04	9.97	13.35	10.22
3/16"	Bronze/Grey	8.66	11.80	11.74	13.74	12.30
1/4"	Bronze/Grey	8.99	12.07			
1/8"	Pattern #62	8.82	10.41			
3/16"	Aquatex	10.73	12.54			
1/4"	.030 Clear Laminated	19.07				
DS	Clear Patio 34" x 76"		86.43		113.44	
5/32"	Clear Patio 46" x 76"		123.83		178.27	

SPECIAL SHAPES AND COMBINATIONS

Archtops	add 60%
Octagons	add 70%
Rectangle Grids (flat muntins avail in 5/8" & 3/4")	add \$3.45 per divided lite (available in green, bronze, champagne, beige, tan, white)
Contour Grids (see page 25)	add \$3.45 per divided lite (available in tan and white)
Trapezoids & Triangles	add 30%
Triple Glazed	add 65%
Argon for annealed and tempered units	add \$0.30 per sq. ft.; minimum order of \$3.00

Maximum area for thickness of glass:

DS (1/8") glass – 16 square feet // 3/16" glass – 35 square feet // 1/4" glass – 42 square feet // Tempered Glass required after 42 square feet

Units over 50 square feet are subject to special pricing.

There is no warranty on units over 50 square feet.

Odd or fractional dimensions will be billed at next even inch.

If manufacturing has been started on an order, and changes or cancellation occur, the customer will be shipped the raw glass and billed for the same.

All prices based on three (3) square foot minimum per unit.

INSULATED GLASS ORDER REQUESTS - SEND TO:

- igorders@wisconsinshowerdoor.com
- Fax to: 888.329.5196

Wisconsin Shower Door
I.G. Unit Fabrication
5803 Packer Drive
Wausau, WI 54401

P: 888.329.5194
F: 888.329.5196

CONTOUR MUNTIN – IN-LINE CLIP

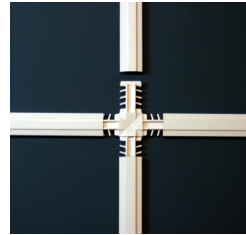

The muntins slide onto the in-line muntin clip.

CONTOUR MUNTIN – SNAP OVER CLIP

INSUL GLASS

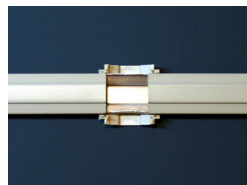
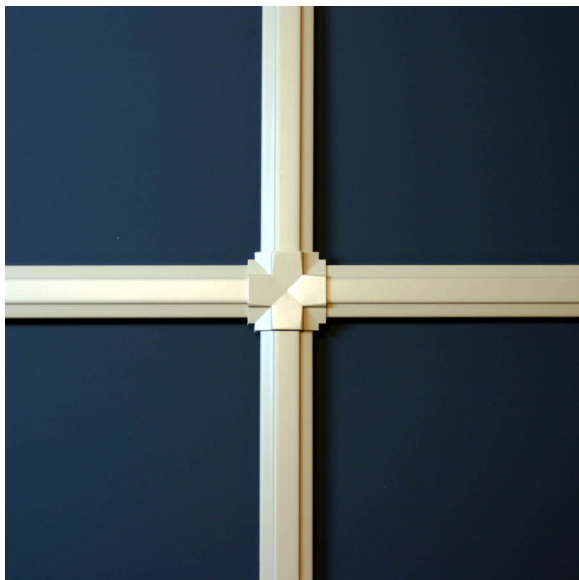

One muntin is cut. One side of a snap over clip is placed at the intersection of the muntins.



The next muntin is placed over the clip and precut muntin.

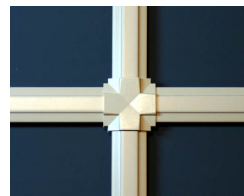

The second side of the snap over clip is put into place and snapped together

I.G. DOOR UNITS

INSULATED GLASS DOOR UNITS FOR COMMERCIAL ENTRANCES

TUBELITE DOORLITES	
30 9/16" x 76 1/16" x 1" OA	73.83
KAWNEER DOORLITES	
31 3/16" x 76 11/16" x 1" OA	73.83

FOAMTITE STORM WINDOWS

FOAMTITE INTERIOR STORM WINDOWS

UNITED INCHES	GLASS	
	SS	DS
0-40	54.40	
41-50	62.52	
51-60	70.80	
61-70	79.26	
71-80	87.89	
81-90	96.69	
91-100		109.22
101-110		118.94
111-120		128.87

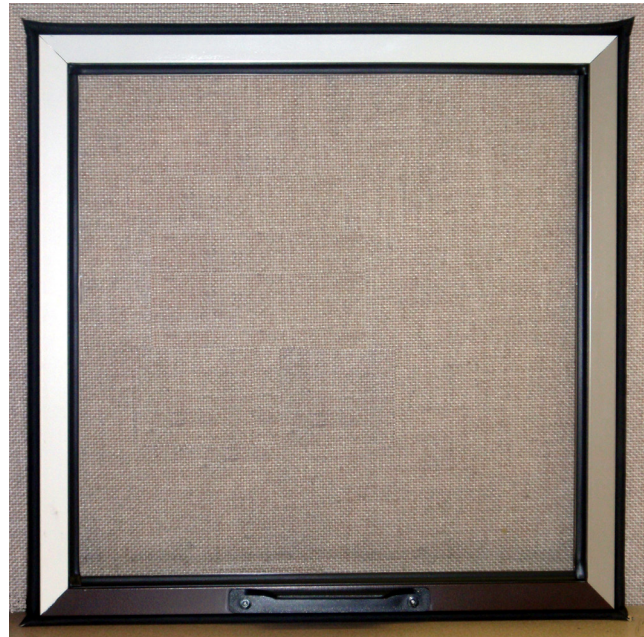

INSUL GLASS

Helps reduce condensation.

Effective against damaging moisture on wood areas with finishes applied.

Replaces applying plastic on windows annually.

Fits in area used by window screen (operating windows).

Can be used with stationary units and other types of windows.

One (1) lift handle (black only) applied for easy handling.

Available in five colors:

- Bronze
- Driftwood
- White
- Mocha
- Green

With black Foamtite weatherstripping.

Extruded aluminum frame.

I.G. UNIT LIMITED WARRANTY

For a period of ten (10) years from the date of purchase, Wisconsin Shower Door warranty is as follows: will not develop material obstruction of vision (on internal glass surfaces) as a result of dust or film formation caused by failure of hermetic seal. Glass is not warrantied against breakage.

Precondition of this warranty is that all insulating glass units be installed in accordance to FGMA glazing manual standards and practices. Furthermore, all units must be installed in such manner as to completely repel water for the entire period of the warranty by use of approved sealants only.

This warranty does not apply to insulating glass units used in vehicles, commercial refrigeration, marine, swimming pool enclosures, greenhouses, airports, sloped applications, and skylights. **This warranty also does not apply to units manufactured with SuperSpacer.** We assume no responsibility for any damage due to thermal breakage or improper use or handling.

This warranty is made to our immediate customer only and all liability shall be limited to replacement of failed unit or refund of the original purchase price. No employee, dealer or agent for Wisconsin Shower Door is authorized to add or modify this warranty.

This warranty is the only warranty made, and it is made expressly in lieu of all other warranties and under no circumstances whatsoever shall we be liable in any way for incidental or consequential damages of any kind with regard to our product.

I.G. UNIT PERFORMANCE CHART

I.G. UNIT GLASS TYPE	% OF VISIBLE LIGHT TRANSMITTANCE	SOLAR HEAT GAIN COEFFICIENT	FADING TRANSMISSION	WINTER U-VALUE AIR / ARGON
Clear/Clear	81	.76	.59	.49 / .47
Clear/Pilkington Energy Advantage (Low E)	77	.75	.49	.33 / .28
Clear/Guardian 7036 ClimaGuard (Low E)	71	.38	.33	.29 / .24

VISIBLE LIGHT TRANSMITTANCE – The percentage of visible light (390 to 700 nanometers) within the solar spectrum that is transmitted through the glass.

SOLAR HEAT GAIN COEFFICIENT – The amount of solar radiation that enters the building as heat. The lower the number, the better the glazing is at preventing solar gain.

FADING TRANSMISSION – The portion of energy transmitted in a special region from 300 to 600 nanometers. This region includes all of the ultraviolet energy and part of the visible spectrum, and will give the best representation of relative fading rates. The lower the number, the better the glass is for reducing fading potential of interior furnishings.

U-VALUE – This represents the heat flow rate through a window expressed in BTU/HR/TR2/°F, using winter weather conditions of 0°F outside and 70°F inside. The lower the number, the better the window system is at reducing heat loss.

A

ACI-15 Deep "J" Molding	26
ACI-21 Shallow "J" Molding	26
ACI-26 L-Bar	26
ACI-29 Face Strip	26
ACI-30 End Cap	26
ACI-51 Little Lip	26

B

Bruce's Glass Stain Remover	28
Buytl Glazing Tape 1/8" x 1/2" x 30"	28
Buytl Glazing Tape 1/16" x 1/2" x 45"	28

C

ClearShield AfterCare	28
ClearShield Limescale Remover	28

D

Deep Shoe	29
Door Pull Assembly - Standard	29
Double Channel - 9/16"	29
Double Track	29
Dow Corning 786	28

G

Glazing Vinyl - 1/4"	29
GMP 2C - Single Outlet	27
GMP 3C - Single Switch	27
GMP 6C - Double Outlet	27
GMP 7C - Outlet / Switch	27
GMP 8C - Double Switch	27
GMP 9C - Triple Switch	27
GMP 10C - Outlet / Double Switch	27
GMP 11C - Quad Switch	27
GMP 12C - Single G.F.I. / Decora	27
GMP 13C - Double G.F.I. / Decora	27
GMP 14C - Single G.F.I. / Switch	27
GMP 15C - Single G.F.I. / Double Switch	27
GMP 16C - Triple G.F.I. / Decora	27
GMP 17C - Quad G.F.I. / Decora	27
GMP 18C - Single G.F.I. / Outlet	27
GMP 104C - Dimmer Switch	27
GMP 305C - Double G.F.I. / Switch	27
Gunther Ultra/Bond Mirror Mastic	28

H

Heavy Duty Wheel Assembly	29
---------------------------	----

I

Invisible Shield	28
------------------	----

L

Lock Assembly - Chrome	29
------------------------	----

M

Mirror Tape - 1/8" x 1/2" x 75'	28
Mirror Tape - 1/16" x 1/2" x 108'	28
Mirror Tape - 1/32" x 1/2" x 216'	28

O

OXO All Purpose Squeegee	28
--------------------------	----

P

Purex Glass Cleaner	28
---------------------	----

S

Shoe	29
SIKASIL GP - General Purpose Acetoxo Cure Silicone	28
SIKASIL SG-10 - Fast Cure Neutral Cure Silicone Assembly Sealant	28
Single Channel - 9/16"	29
Single Channel - 13/16"	29







T

Top Guide	29
Tri-View Mirror Frame	29















W

Wardrobe Door	29
Wheel Assembly	29



ANDSCOT METALS

PROFILE	PART	SIZE/ QTY	SILVER	SATIN	MATTE BLACK	BRUSHED NICKEL	OIL RUBBED BRONZE
	ACI-15 – Deep “J” Molding	12’	27.04		37.19	26.75	33.63
	ACI-21 – Shallow “J” Molding	12’	27.04		37.19	26.75	
	ACI-26 – L-Bar	12’	22.78				
	ACI-51 – Little Lip	12’	20.13				
	ACI-29 – Face Strip	12’	8.66				
	ACI-30 – End Cap <i>Subject to availability</i>	12’	14.07				



CLEAR MIRROR COVER PLATES

IMAGE	PART	SIZE/ QTY	PRICE
	GMP 2C – Single Outlet	each	16.49
	GMP 3C – Single Switch	each	11.91
	GMP 6C – Double Outlet	each	22.30
	GMP 7C – Outlet / Switch	each	18.24
	GMP 8C – Double Switch	each	13.93
	GMP 9C – Triple Switch	each	19.46
	GMP 10C – Outlet / Double Switch	each	21.76
	GMP 11C – Quad Switch	each	24.78
	GMP 12C – Single G.F.I. / Decora	each	17.91
	GMP 13C – Double G.F.I. / Decora	each	24.45
	GMP 14C – Single G.F.I. / Switch	each	22.90
	GMP 15C – Single G.F.I. / Double Switch	each	31.52
	GMP 16C – Triple G.F.I. / Decora	each	33.88
	GMP 17C – Quad G.F.I. / Decora	each	54.52
	GMP 18C – Single G.F.I. / Outlet	each	24.45







CLEAR MIRROR COVER PLATES

IMAGE	PART	SIZE/ QTY	PRICE
	GMP 104C – Dimmer Switch	each	28.36
	GMP 305C – Double G.F.I. / Switch	each	33.37







SILICONE PRODUCTS

IMAGE	PART	SIZE/ QTY	PRICE EA
	SIKASIL GP – General Purpose Acetoxy Cure Silicone 432063 – Clear	tube	8.21
		case (24)	176.00
	SIKASIL-N PLUS US – Neutral Cure Silicone 432053 – Clear	tube	7.94
		case (24)	170.24
	Dow Corning 786 Silicone Translucent White	tube	10.87
		case (12)	116.52















SUNDRIES

IMAGE	PART	SIZE/ QTY	PRICE
	Gunther Ultra/Bond Mirror Mastic 300ml tube	each	6.49
	Mirror Tape – 1/32" x 1/2" x 216'	roll	12.00
	Mirror Tape – 1/16" x 1/2" x 108'	roll	7.01
	Mirror Tape – 1/8" x 1/2" x 75'	roll	8.28
	Bruce's Glass Stain Remover 10 oz. container	each	7.28
		case (6)	39.00
	Invisible Shield 16 oz. bottle	each	10.81
		case (12)	115.84

SUNDRIES

IMAGE	PART	SIZE/ QTY	PRICE
	Butyl Glazing Tape 1/16" x 1/2" x 45"	roll	3.12
		case (28)	83.57
	Butyl Glazing Tape 1/8" x 1/2" x 30"	roll	3.22
		case (28)	86.24
	Hang-It™	each	6.79
	Purex Glass Cleaner 5 gallon box	each	59.90
	Purex Glass Cleaner 32 oz. bottle	each	14.27
		case (12)	152.99
	ClearShield AfterCare 500ml bottle	each	13.96
	ClearShield Limescale Remover 500ml bottle	each	16.78

STYLMARK

PROFILE	PART	SIZE/ QTY	PRICE
	Single Channel – 9/16" - 110022 <i>Silver</i> <i>Brushed Nickel</i>	12'	25.37
	Single Channel – 13/16" - 110023 <i>Silver</i> <i>Brushed Nickel</i>	12'	32.00
	Double Channel – 9/16" - 110007 <i>Satin Silver</i> <i>Satin Bronze</i> <i>Satin Gold</i>	12'	31.73
	Double Track - 110019 <i>Satin Silver</i> <i>Satin Bronze</i> <i>Satin Gold</i>	12'	22.73
	Shoe - 110012 <i>Satin Silver</i> <i>Satin Bronze</i> <i>Satin Gold</i>	12'	34.36
	Deep Shoe - 110067 <i>Satin Silver</i> <i>Satin Bronze</i> <i>Satin Gold</i>	12'	38.22
	Wheel Assembly - 510001	each	1.37
	Heavy Duty Wheel Assembly - 510041	each	1.57
	Top Guide - 419007	each	0.24
	Glazing Vinyl – 1/4" - 119004 <i>Black</i>	per foot 250' roll	0.39 97.02
	Door Pull Assembly – Standard - 510016 <i>Satin Silver</i> <i>Black</i>	each	12.46
	Lock Assembly – Chrome - 510040 <i>Brite Silver</i>	each	40.73
	Wardrobe Door - 630017 Standard & Custom Sizes	each	Quote
	Tri-View Mirror Frame - 620033 Standard & Custom Sizes	each	Quote

HANG-IT™

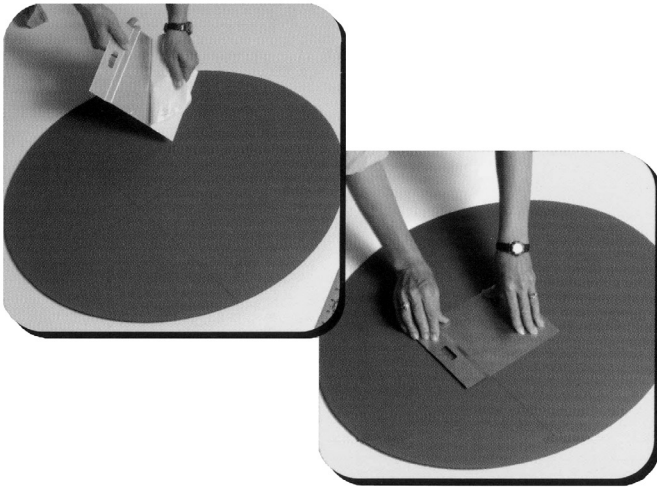

Hang-It™ has been designed to be used with all types of mirrors. It's high strength adhesive backing adheres to all mirror paint backings that meet industry standards. Hang-It™ saves time and labor when installing decorator mirrors. Simply peel off the protective paper on the back of the metal hanger, align the saw tooth slot of the metal hanger with centering lines you have established on the mirror, and press in place. Hang your new mirror on the wall making sure the saw tooth slot is positioned where you want the mirror to be hung.

INSTALLATION INSTRUCTIONS

1. Clean any contaminants from the back of the mirror, using a mixture of alcohol and water or denatured alcohol.
2. Locate the center of the mirror and draw a vertical line from the top to the bottom.
3. Measure down 3" to 6" from the top of the mirror and make a mark on the centering line. This marks the location from the top of the hanger.
4. Locate the center of the hanger. Mark with a line. (The saw tooth slot is centered at the top of the hanger.)
5. Peel the adhesive protective paper from the back of the hanger. Align the centering marks on the mirror and hanger. Press in place, making sure the Hang-It™ bracket is making full contact with the back of the mirror.

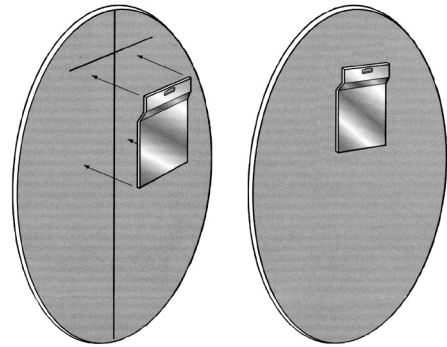

PRECAUTIONS

1. Make sure mirror and Hang-It™ are applied at or above 60° room temperature when assembled.
2. After installing Hang-It™ on the mirror, wait at least 2 hours before hanging the mirror. The adhesive gains strength in time and fully cures in 7 days.
3. Hang-It™ will support decorator mirrors weighting up to 40 lbs.
4. Always use gloves when handling mirrors, to protect yourself and avoid damaging the mirror.

ROBAX® GLASS

ROBAX® glass-ceramic has a thermal endurance far exceeding that of normal tempered glass. Tempered glass is generally limited to applications that do not exceed 500° F. However, ROBAX® is designed to operate at temperatures ranging from minus 400° F to plus 1400° F. Because of its special composition and processing, this unique material can withstand a quench into ice water from red hot temperatures.

With ROBAX® glass-ceramic windows in your stove or fireplace, you can enjoy the fire view with the assurance that the window has been designed with a superior margin of safety for your home and your family.

- This material is actually a transparent glass-ceramic manufactured by Schott Glaswerkes.
- Unlike tempered glass, 1400° glass-ceramic is unstressed.
- Easily cut and sanded – even drilled.
- Will not shatter (like tempered glass).
- Fire to ice without breaking.
- Good strength.

This is an excellent replacement in most applications for any of the following glasses: PYREX®, BOROFLOAT®, TEMPAX®, VYCOR®, PYROCERAM®, AND NEOCERAM®.

Typical applications include: wood stove, pellet stove and coal stove windows; wood and gas fireplace doors; oven door windows; high intensity light covers; furnace observation windows; barbecue grill windows; spark and flame guard panels.



In the photo above, a cutting torch was placed below the ROBAX® and heated until it was red-hot. Cold water was then poured onto the glass from above. There was NO Breakage.

ENDUROSHIELD

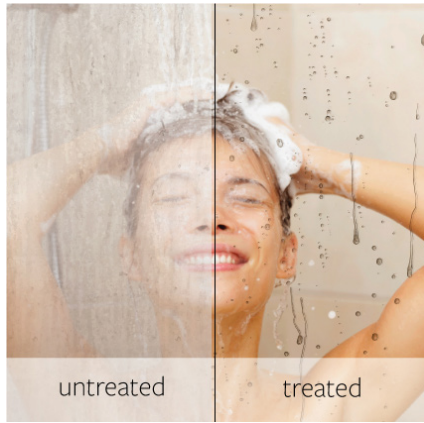
Save time and money with EnduroShield®, the revolutionary, non-stick treatment that is ideal for shower glass. EnduroShield glass treatment makes cleaning shower glass easy and repels soap scum, grime and dirt. EnduroShield reduces your cleaning time by up to 90%.

Untreated glass is porous and as a result absorbs mineral deposits and soap scum, making it more and more difficult to clean overtime. Shower glass is subject to mineral deposits from water, shampoo, soaps, body fats, and harsh scrubbing using toxic cleaners, causing the glass to discolor and develop irremovable staining. EnduroShield is an ultra-thin transparent glass coating that completely adheres to the surface and provides protection that will repel both water and oil based stains. Similar to a non-stick fry pan, cleaning is made easier using a mild detergent or white vinegar with a damp microfiber cloth. No longer is scrubbing with harsh toxic cleaners needed.

WARRANTY

Extensive testing has proven EnduroShield to last beyond 10 years, enabling a genuine 10-year limited warranty* on all new glass surfaces.

CARE & MAINTENANCE

For best results simply drying the glass with a squeegee or towel after each use will help keep the glass clean and reduce mineral spots forming. The glass needs to be cleaned every few weeks using a damp microfiber cloth and a mild detergent to break down soaps, oils, and conditioners on the glass.

The below products have been tested for compatibility with EnduroShield.

- Lysol 4 in 1 Bathroom Cleaner
- Fantastik Orange Action
- Green Works Natural Glass & Surface Cleaner (by Clorox)
- Mr. Clean Magic Eraser (when damp)

A thorough rinse with clean water should follow immediately after use of any cleaner.

CAUTION: Prohibited Products

Be careful not to use any rough, gritty, abrasive, highly acidic or alkaline cleaners as they may damage the protective coating. This includes products such as Comet (powder), Ajax, or cerium oxide which damage or polish back the actual substrate.

For warranty registration, additional information, and full care instructions visit www.enduroshield.com.

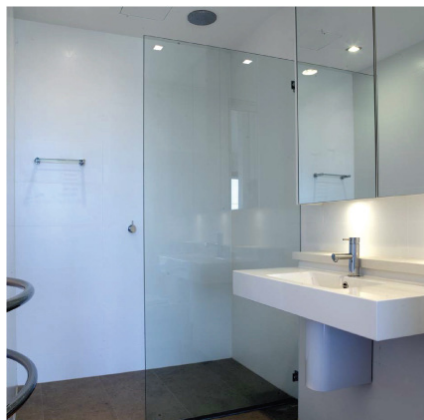

Wisconsin Shower Door

Proud of our past; focused on our future.

Wisconsin Shower Door
N85 W13780 Leon Road
Menomonee Falls, WI 53051

P: 262.251.0088
F: 262.251.0718

Toll Free P: 866.318.0088
Toll Free F: 800.232.1471

Wisconsin Shower Door
I.G. Unit Fabrication
5803 Packer Drive
Wausau, WI 54401

P: 888.329.5194
F: 888.329.5196

